



SENNHEISER

SDW 5000 Series

DECT Wireless Headset System

SDW 10 HS

SDW 3 BS

SDW 5 BS

BTD 800 USB



User Guide

Contents

Package contents	2
Base stations with components	2
Headset with components	2
Product overview	3
Overview of the base station	3
Overview of the headset	4
Overview of the BTD 800 USB dongle	5
Overview of the LEDs	5
Connecting the base station	7
Connecting the base station to the mains power supply	8
Pairing and charging the headset before first use	8
Connecting the base station to a fixed line phone – SDW 5 BS only	9
Connecting the base station to a computer	11
Connecting the base station to Bluetooth devices – BTD 800 USB only	12
Reconnecting/disconnecting Bluetooth	14
Connecting an optional USB headset or speakerphone	15
Connecting an optional busy light	15
Assembling and wearing the headset	16
Using the headset with the headband	16
Using the headset with the ear hook	17
Using the headset with the neckband	19
Detaching headband, ear hook or neckband	21
Labeling the headset	22
Configuring the headset system	23
Configuring the headset system using HeadSetup™ Pro or the DIP switches	23
Adjusting the audio signal for desk phones using the ABC switch – SDW 5 BS only	27
Adjusting the transmission volume	27
Setting up and using the headset	28
Adjusting the volume	28
Muting the headset's microphone	29
Enabling/disabling voice prompts	29
Verifying battery life	30
If you leave the DECT or Bluetooth range	30
Making calls using the headset system	31
Preparing calls - initial settings	31
Selecting audio source – fixed line phone/ computer/ mobile phone	31
Making a call	32
Accepting/rejecting a call	32
Transferring calls to connected devices	33
Ending a call	34
Redialing	34
Managing multiple calls - two calls from two audio sources	35
Setting up conference call	37
Using the dictation mode	40
Listening to music using the headset	41
Using the motion sensor	42
Charging the headset and storing the headset system	43
Charging the headset	43
Switching the headset system off during extended non-use	44
Sharing a workplace	45
Using the headset with a third party base station (DECT-GAP telephone)	45
Cleaning and maintaining the headset system	46
Replacing the ear pads	46
Replacing/removing the headset's rechargeable battery	47
Updating the firmware of the products	47
If a problem occurs	48
Specifications	50

Package contents

In the SDW 5000 Series, all headsets and base stations are compatible with each other, allowing you to combine the products to meet your needs.

i For safety instructions, consult the Safety Guide.
 A list of accessories can be found on the product page at www.sennheiser.com/headsets. For information on suppliers, contact your local Sennheiser partner: www.sennheiser.com/headsets > “Find a dealer”.

Base stations with components

<p>SDW 3 BS</p> <p>SDW 5 BS</p> <p>Quick Guide, Safety Guide, Compliance sheet</p> <p>EU/UK/US/AUS</p>	<p>SDW 3 BS</p>	<p>SDW 5013 bundle</p> <p>✓</p>	<p>SDW 5014 bundle</p> <p>✓</p>	<p>SDW 5015 bundle</p>	<p>SDW 5016 bundle</p>
<p>SDW 5 BS</p>	<p>SDW 5 BS</p>			<p>✓</p>	<p>✓</p>
<p>BTD 800 USB</p>	<p>BTD 800 USB</p>		<p>✓</p>		<p>✓</p>

Headset with components



Headband

Ear hook and adapter

Neckband



*The wearing style adapter is also needed for assembling the neckband (see page 19).

Product overview

Overview of the base station

Overview of the front

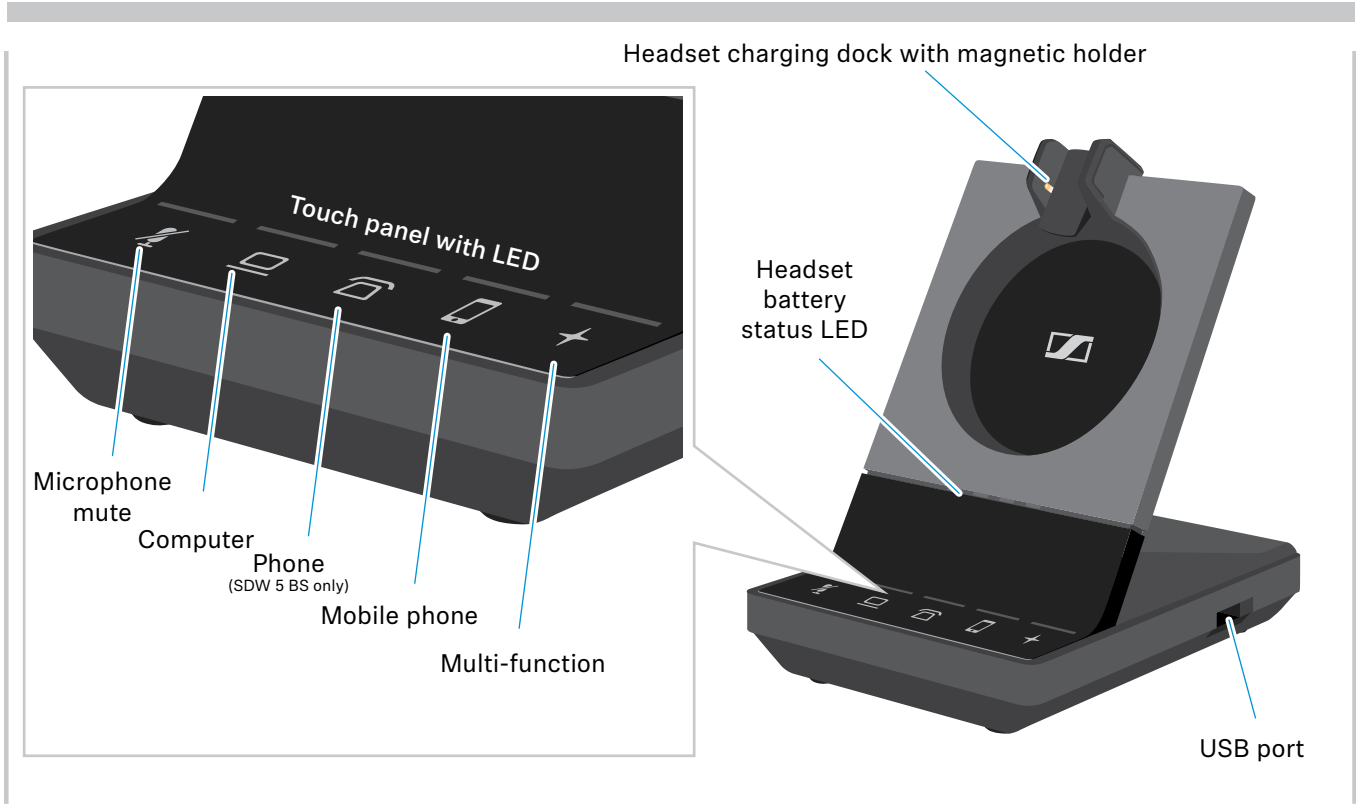

Overview of the rear sockets

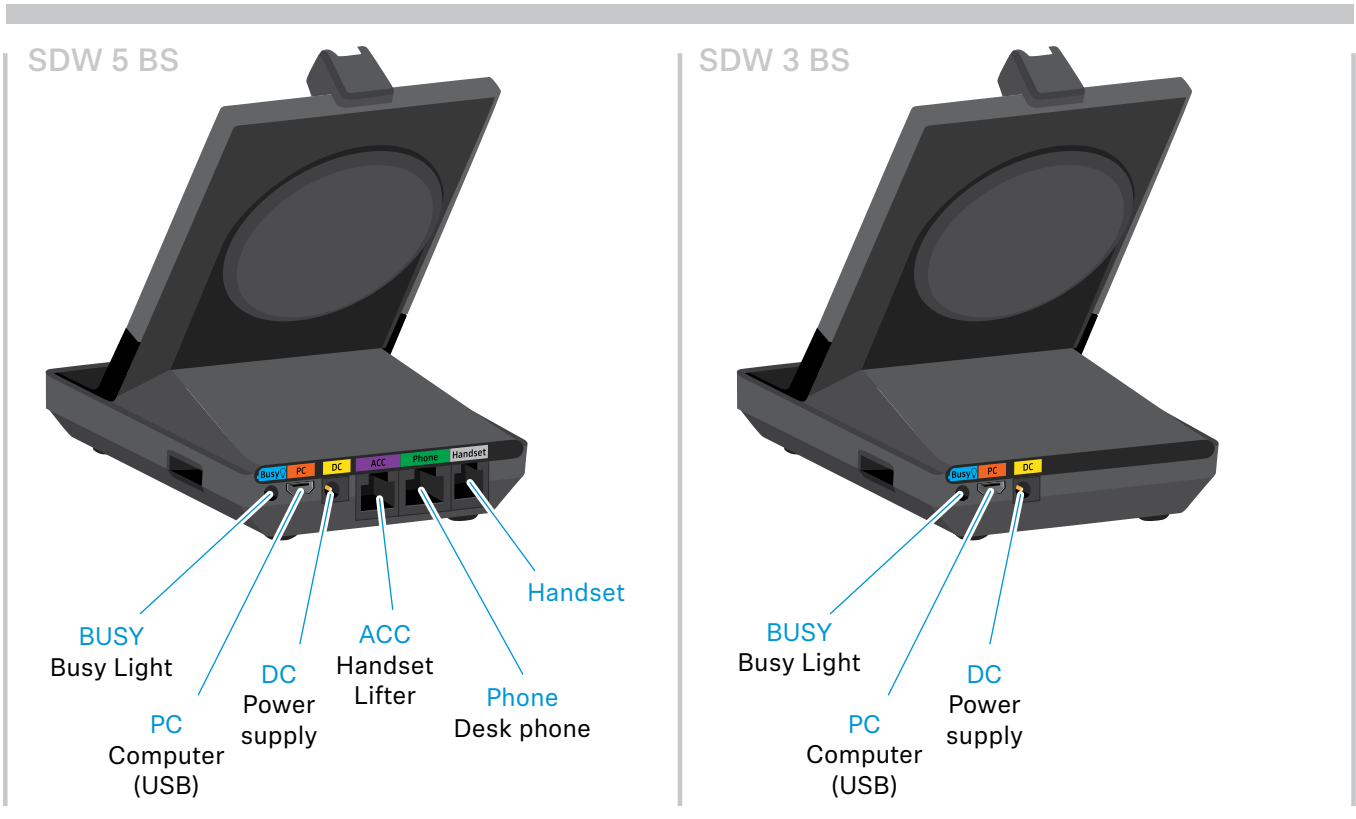

Overview of the bottom

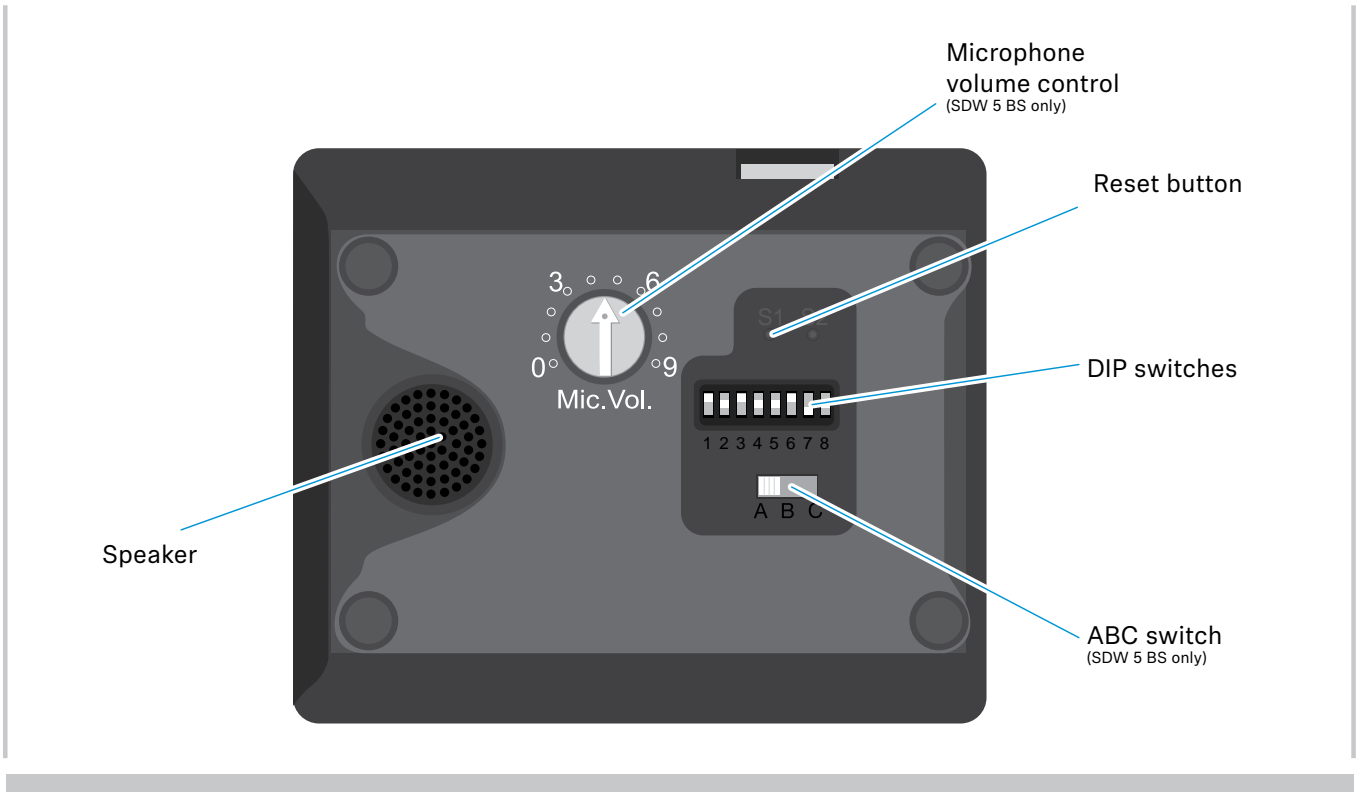

Overview of the headset

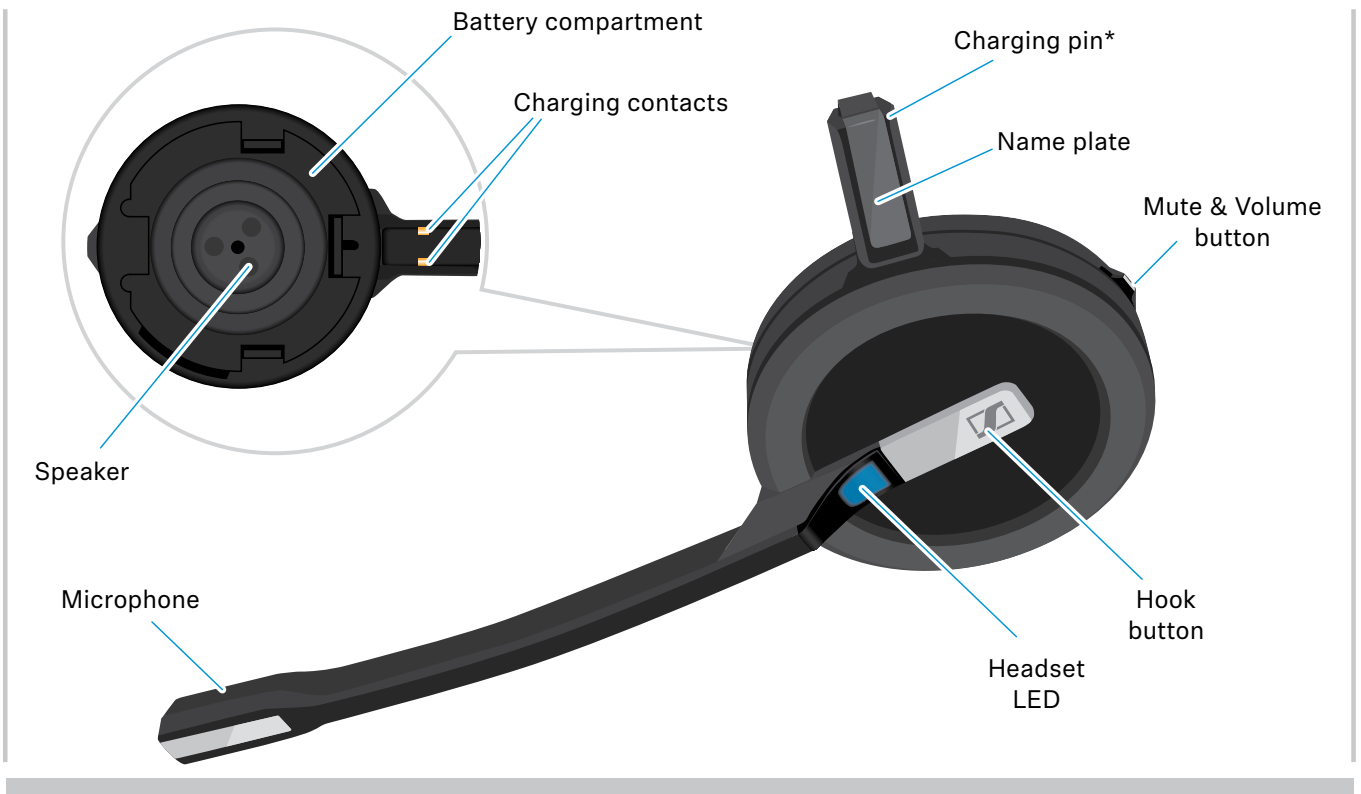





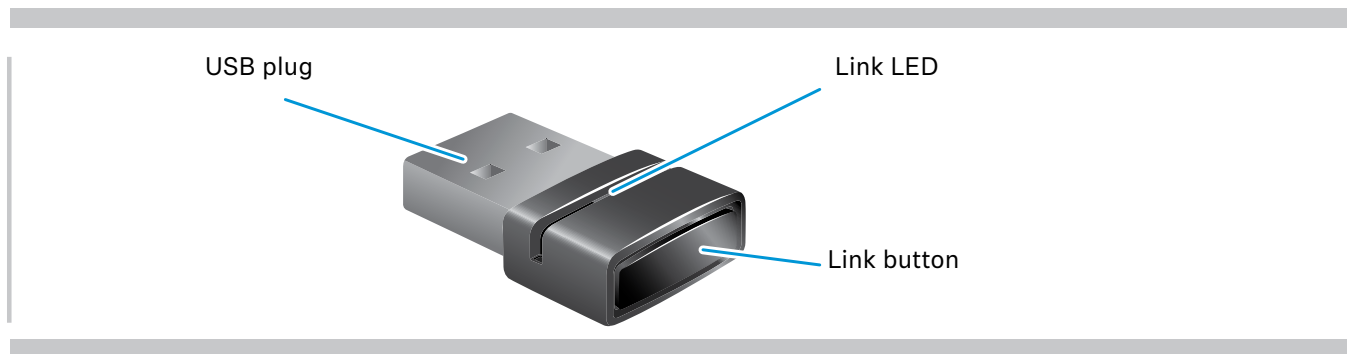



















*Inserted into the holder of the headband or wearing style adapter

Overview of the BTD 800 USB dongle













Overview of the LEDs









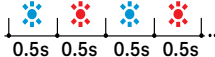

Overview of the base station LEDs

Base station	LED	Meaning
	 off	Headset microphone is active
	 constant	Headset microphone is muted
	 off	Corresponding device is not in focus*
	 constant	Corresponding device is in focus* *Focus device: the device that initiates an outgoing call when the headset's hook button is tapped.
	 constant	<ul style="list-style-type: none"> outgoing call / active call Merged calls from two audio sources: two LEDs light up  +  /  +  /  + :
	 flashes fast	Incoming call
	 flashes slow	Call on hold
	 off	No external USB or Bluetooth headset connected/ no music
	 constant	<ul style="list-style-type: none"> USB headset connected or Bluetooth headset connected via dongle
	 constant	No headset connected
	 flashes	<ul style="list-style-type: none"> Incoming call - no headset connected Connected USB headset is not supported
	 constant*	Music streaming * The LED is off per default and can be enabled via HeadSetup™ Pro.
	 constant	Dictation mode on
	segments 1 – 4 are lit	Charging status of the headset battery (see page 43)
	off	<ul style="list-style-type: none"> Headset battery flat no SDW 5000 headset connected





Overview of the headset LED

Headset	LED	Meaning
		<ul style="list-style-type: none"> Headset is being charged in the base station Headset fully charged in CH 30 charger
		Headset is being paired to base station
		<ul style="list-style-type: none"> Headset switches on Headset successfully connected to the base station
		Headset switches off
		Incoming call
		<ul style="list-style-type: none"> Outgoing/active call Softphone status: BUSY
		Music streaming <small>* The LED is off per default and can be enabled via HeadSetup™ Pro.</small>
		Headset is fully charged in the base station
		Firmware upgrade

Overview of the dongle BTD 800 USB LED

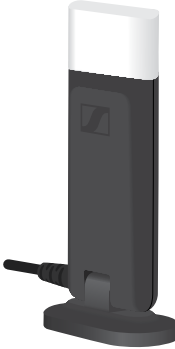
Dongle	LED	Meaning
	mode 1: 	Dongle in pairing mode: searching for Bluetooth devices to pair and connect
	mode 2: 	<ul style="list-style-type: none"> Search mode 1: Mobile phone Search mode 2: Bluetooth headset
		Pairing successful
		Pairing failed
		Dongle tries to connect to a Bluetooth device
		Dongle and Bluetooth device connected
		<ul style="list-style-type: none"> Outgoing/active call Music streaming in standard quality
		Incoming call
		Music streaming in high quality
		Microphone of the connected Bluetooth device is muted

Overview of the busy light LED UI 10 BL

Busy light	LED	Meaning
		<ul style="list-style-type: none"> Presence status softphone: AVAILABLE No active call Music streaming
		<ul style="list-style-type: none"> Presence status softphone: AWAY/ be right back Headset out of range No headset connected
		<ul style="list-style-type: none"> Presence status softphone: BUSY/ Presenting/ Do not disturb Active call on softphone, desk phone or mobile phone UC* client in meeting

*UC Client = Unified communications client such as Microsoft® Skype for Business

Connecting the base station

The base station controls the wireless communication to the headset.

Depending on the variant you can plug in the headset system to your fixed line phone and/or your computer.



Via the Bluetooth dongle BT-D 800 USB you can connect mobile phones or Bluetooth headsets.

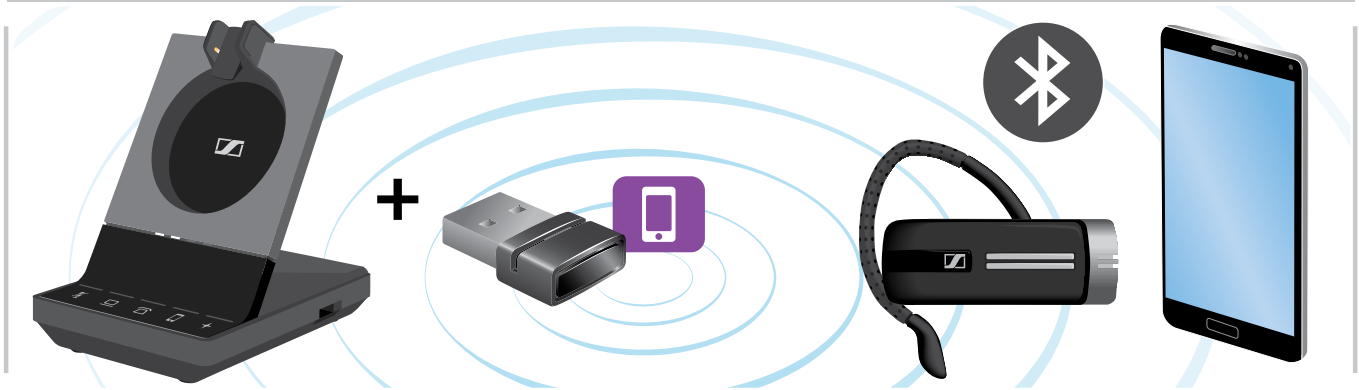

Additionally you can plug a USB headset or speakerphone in the USB port or the busy light UI 10 BL in the back of the base station.



Connecting the base station to the mains power supply

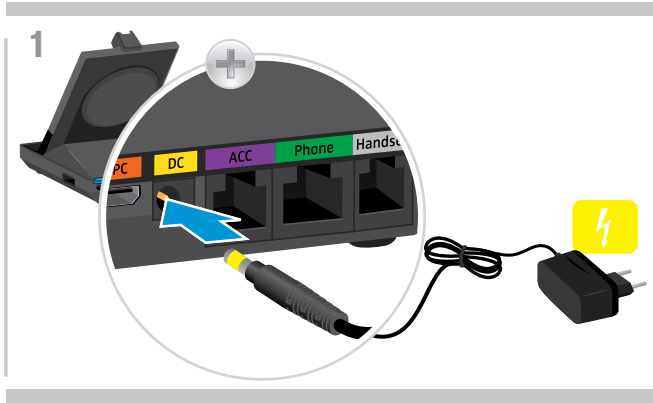

- ▶ Connect the plug of the power supply unit to the DC socket (marked yellow).



- ▶ Connect the power supply unit to a wall socket. The + LED lights up red. See page 11 for supported features with and without power supply connection.

Disconnecting the base station from the mains power supply

- ▶ Unplug the power supply unit from the wall socket, if the product is not used for extended periods of time.

Pairing and charging the headset before first use

- ▶ Charge the rechargeable battery for at least 20 minutes before using it for the first time. A complete charging process takes about 60 minutes (see page 43).



- ▶ Place the headset into the magnetic holder of the base station. The Headset battery status LEDs on the base station indicate the charge status.

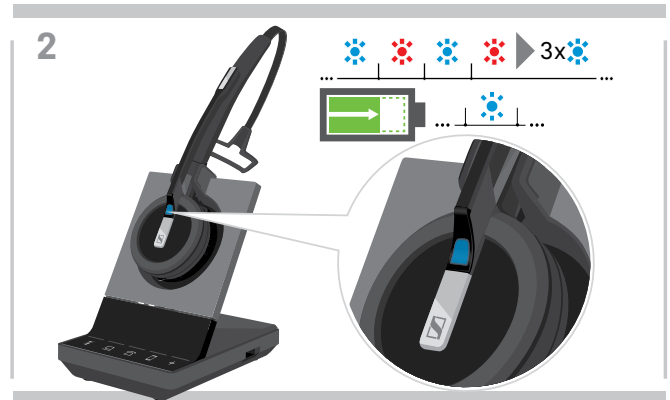

- If the headset and base station are not paired, the headset LED flashes blue and red shortly. The LED turns blue when pairing is complete and the headset will start charging.

- i** During the first charging process and after long periods of non-use, it may take up to 5 minutes until the headset LED lights up.

Connecting the base station to a fixed line phone – SDW 5 BS only

- ▷ Check which connection possibility is best suited for your telephone and follow the instructions in the corresponding chapter **A**, **B**, **C** or **D**.
- ▷ Place the base station at a minimum distance of 15 cm from the fixed line phone.



Connecting the base station to a fixed line phone without headset socket

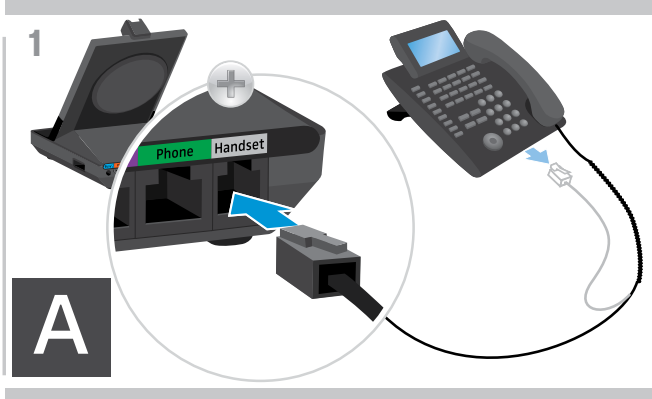

- ▷ Disconnect the handset cable from the telephone.
- ▷ Connect it to the **Handset** socket on the base station.

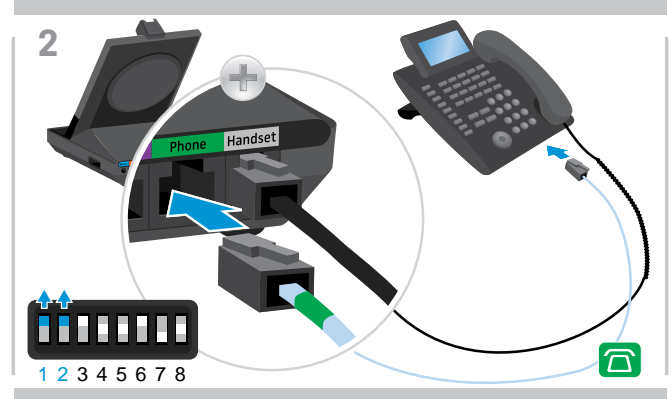

- ▷ Connect the telephone cable to the handset socket and to the **Phone** socket on the base station.
- ▷ Use a pointed object to set the DIP switches **1** and **2** at the bottom of the base station to the position shown.

Connecting the base station to a fixed line phone with headset socket

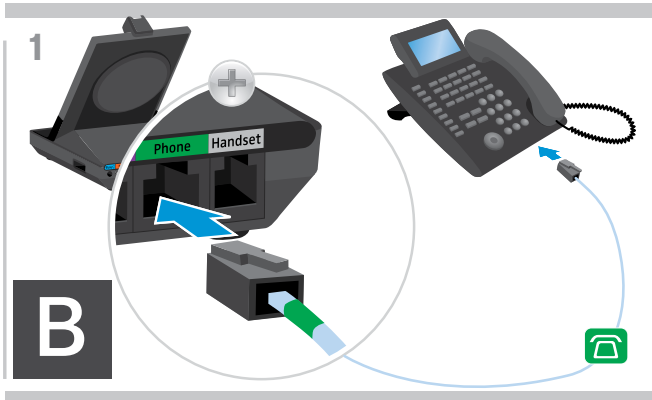

- ▷ Connect the telephone cable to the headset socket on the telephone and to the **Phone** socket (marked green) on the base station.

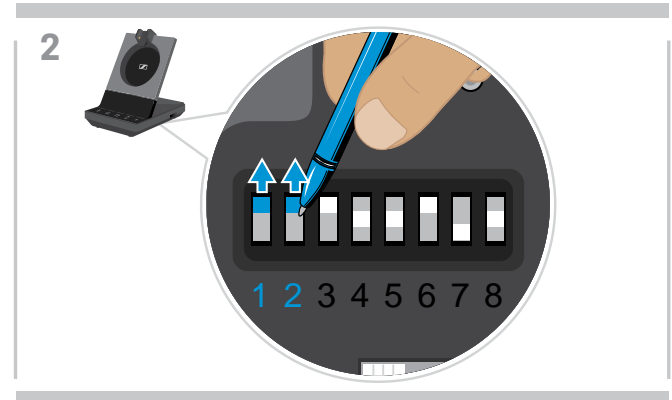

- ▷ Use a pointed object to set the DIP switches **1** and **2** to the position shown.

Connecting the base station to an optional mechanical handset lifter

The handset lifter allows you to answer calls even when you are away from your desk. The Sennheiser HSL 10 II mechanical handset lifter is available from your Sennheiser partner.

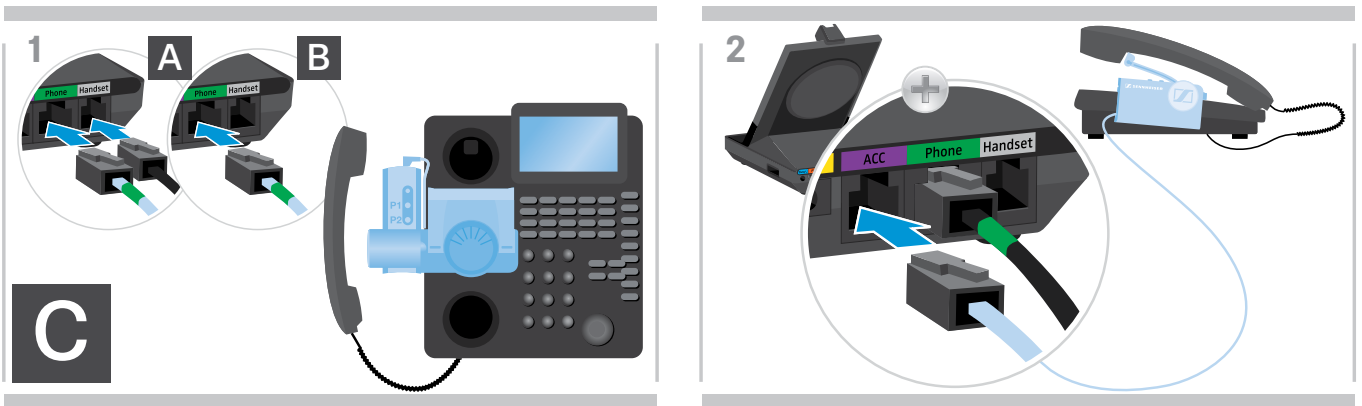

- ▷ Connect the base station to the fixed line phone as described in chapter A or B.
- ▷ Connect the handset lifter to the fixed line phone. For more information, refer to the instruction manual of the HSL 10 II handset lifter.
- ▷ Connect the handset lifter to the ACC socket on the base station.

Connecting the base station to an optional electronic hook switch control (EHS)

The necessary EHS connection cables as well as adapter cables for manufacturer specific standards are available from your Sennheiser partner.

For further information concerning corresponding phones and cables visit www.sennheiser.com/headsetcompatibility.

Quick Guides are supplied with the cables or can be found on the product page on our website at www.sennheiser.com/headsets.

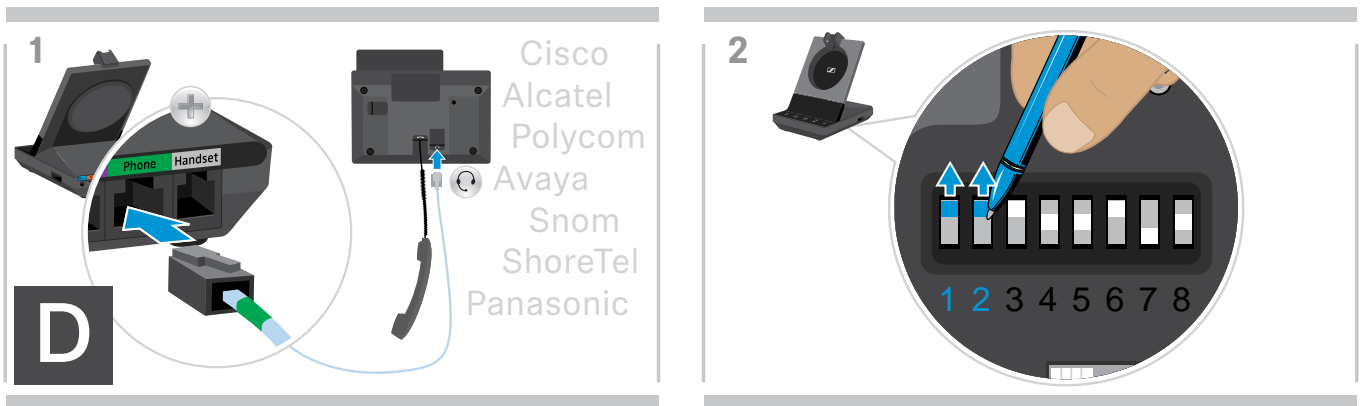

- ▷ Connect the base station to the fixed line phone as shown in the cable Quick Guide.
- ▷ Use a pointed object (e.g. a ball pen) to set the DIP switch to the position shown in the cable Quick Guide.

Connecting the base station to a computer

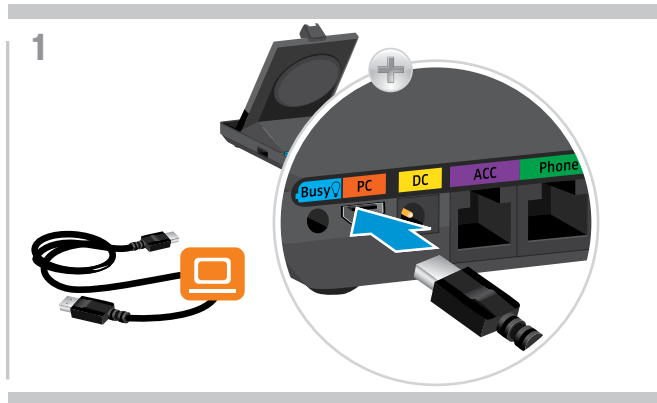

- ▷ Connect the USB cable to the PC socket on the base station.

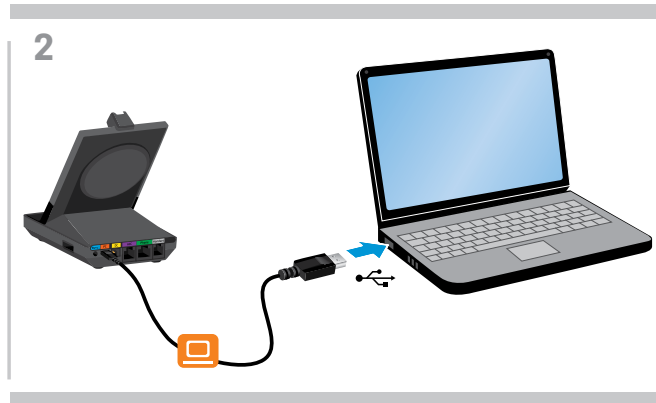

- ▷ Connect the USB cable to a USB socket on your computer.
The operating system detects the USB audio device “Sennheiser SDW 5 BS” or “Sennheiser SDW 3 BS” and installs the necessary drivers.

Installing Sennheiser software

The Sennheiser software allows you to add value to your Sennheiser products. **HeadSetup™ Pro** enables easy set-up, configuration and update of your SDW 5000 series.



- ▷ Download the software from www.sennheiser.com/software.
▷ Install the software.
To install the software, you need administrator rights on your computer. If necessary, contact your IT department.

To make calls via the computer:

- ▷ Install a softphone (VoIP Software), such as Skype for Business or ask your admin for support.

Features with and without power supply connection

Feature	Power via USB only	Power via USB + power supply unit
Full softphone functionality	✓	✓
Conferencing with multiple SDW 5000 headsets	✓	✓
Desk phone connection	✗	✓
USB port functions: Bluetooth headsets & mobile via dongle, USB headsets & speakerphones	✗	✓
Busy light support	✗	✓
Fast charging	✗	✓

Connecting the base station to Bluetooth devices – BTD 800 USB only

With the dongle BTD 800 USB you can either connect mobile phones or headsets via Bluetooth to the base station.

The dongle complies with the Bluetooth 4.2 standard. Pair Bluetooth devices that support the “hands free profile” (HFP), the “headset profile” (HSP) or the “advanced audio distribution profile” (A2DP).



The dongle can save up to eight paired Bluetooth devices. If you pair a ninth device, the saved connection profile of the least used Bluetooth device will be overwritten. If you want to re-establish a connection with this device, you have to pair the devices again.



After switch-on, the dongle automatically tries to connect to the two last connected Bluetooth devices. If two devices are used, either two mobile phones or two headsets can be connected to the dongle – mobile phone and Bluetooth headset cannot be combined. You can only connect a third Bluetooth device after having switched off the first or the second Bluetooth device.

Connecting the Bluetooth dongle to the base station

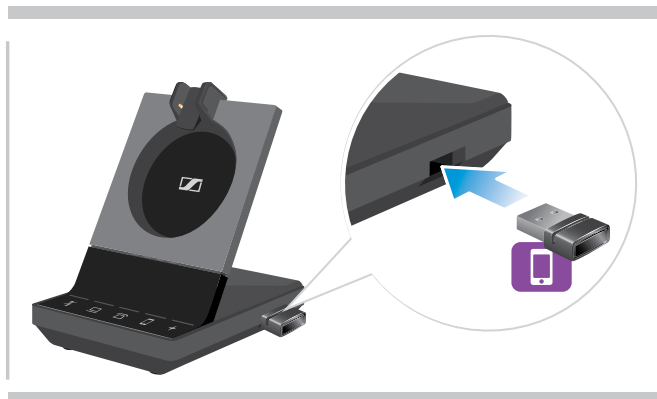

The BTD 800 USB dongle is supplied together with the SDW 50X4 and SDW 50X6 bundles and also available as an accessory.

- ▶ Plug the dongle into the USB port of the base station.
- ▶ Follow the instructions in one of the two next chapters. New unused dongles switch automatically to pairing mode. The LED alternately flashes blue and red.

Pairing a mobile phone or tablet via Bluetooth



▶ Activate Bluetooth on your mobile phone or tablet (see the instruction manual of your device).

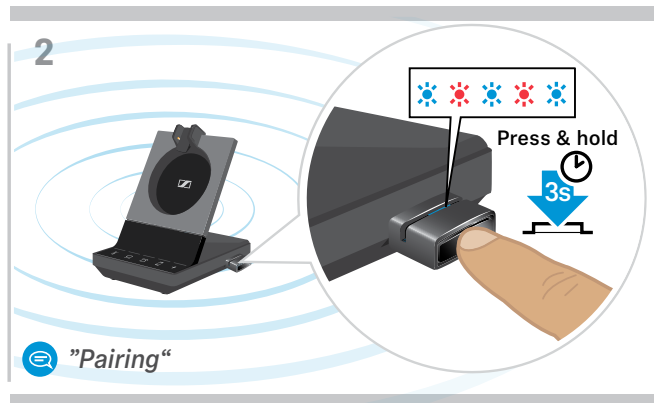

▶ Press and hold the dongle's button for 3 seconds to enter pairing mode. The LED alternately flashes blue and red.



▶ Start the search for new Bluetooth devices. All available devices in the proximity of your mobile phone or tablet are displayed.

▶ Select "Sennheiser BTD 800 USB" to pair the dongle. If necessary, enter the default PIN code "0000".

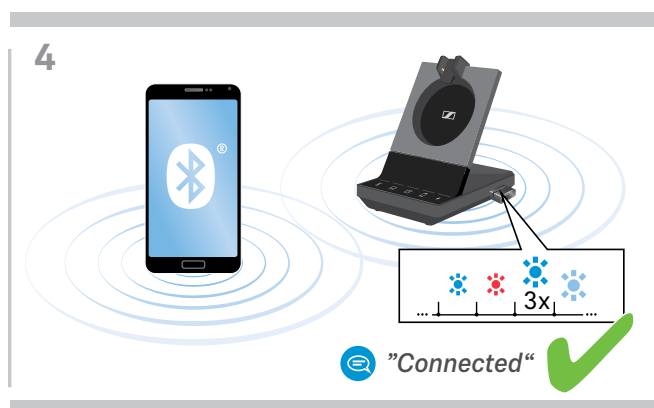

Once the Bluetooth devices are paired, the LED flashes 3 times blue and then lights up in a constant dim blue.

Pairing a headset via Bluetooth

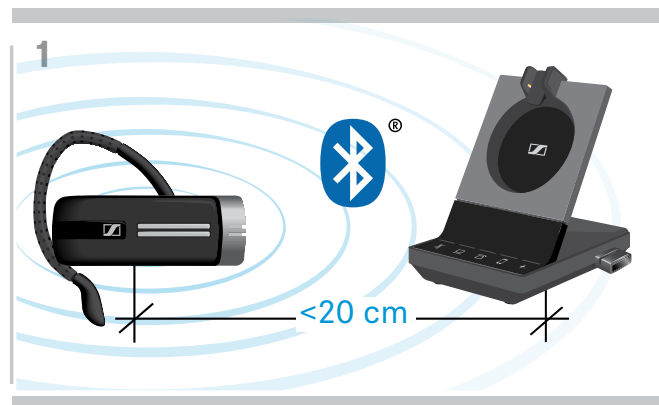

- ▶ Activate the pairing mode on your Bluetooth headset (see the instruction manual of your device).

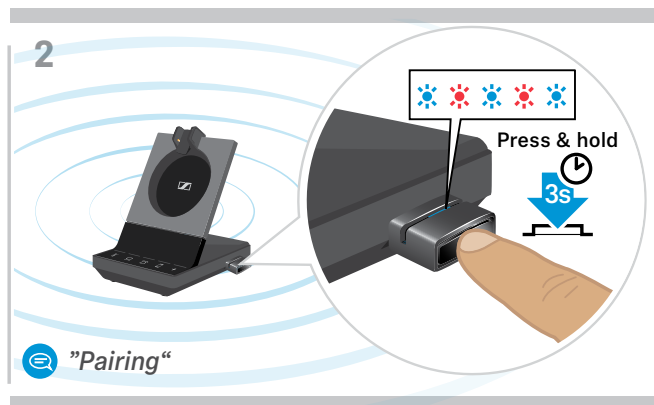

- ▶ Press and hold the dongle's button for 3 seconds to enter pairing mode. The LED alternately flashes blue and red.

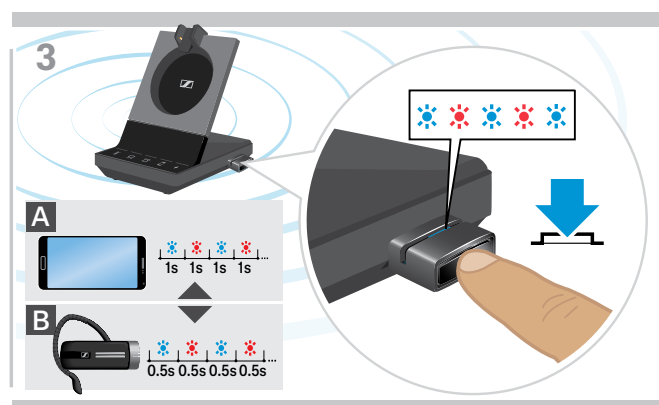

- ▶ Press the button again to switch between pairing mode for mobile phones **A** or headsets **B**.

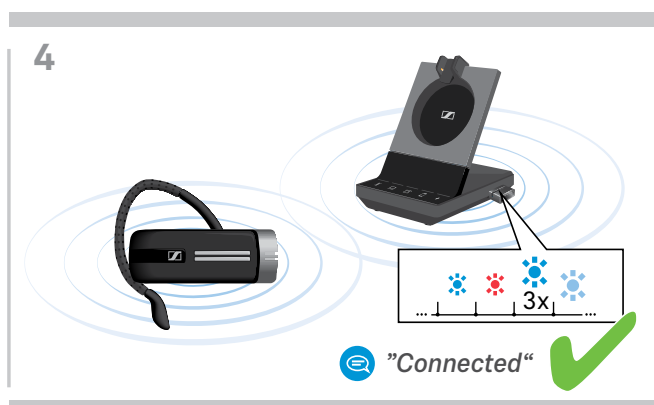

- ▶ Once the Bluetooth devices are paired, the LED flashes 3 times blue and then lights up in a constant dim blue.

Clearing the list of previously paired devices

- ▶ Press and hold the dongle's button for 3 seconds to enter pairing mode. The LED alternately flashes blue and red.
- ▶ Double press the dongle's button. The LED flashes purple three times. The pairing list is cleared.

Reconnecting/disconnecting Bluetooth

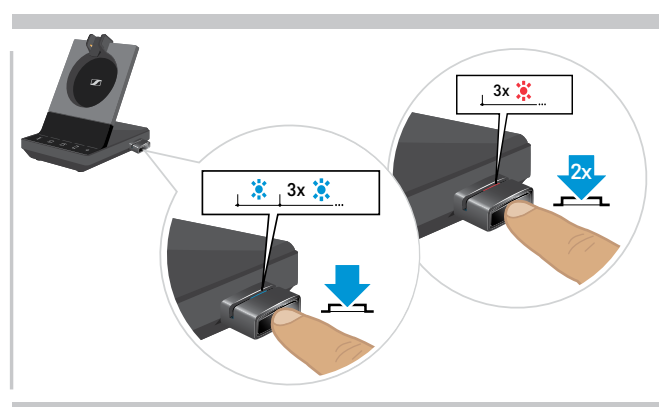

To reconnect a Bluetooth device:

- ▶ Tap the dongle's button. The LED lights up blue once and after that flashes 3 times blue. The LED is lit constantly in dim blue.

To disconnect a Bluetooth device:

- ▶ Double tap the dongle's button. Bluetooth will be disconnected. The LED flashes 3 times red. The dongle starts flashing blue and searches for other Bluetooth devices.

Connecting an optional USB headset or speakerphone

You can connect a Sennheiser USB headset or a USB speakerphone at any time, if for example the battery of your SDW headset is empty or to add other participants to your conference call.

Connecting a USB headset

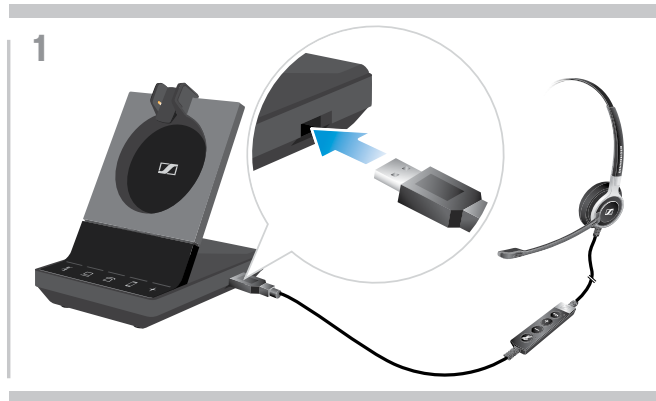

▶ Connect the headset to the **USB** socket on the base station.

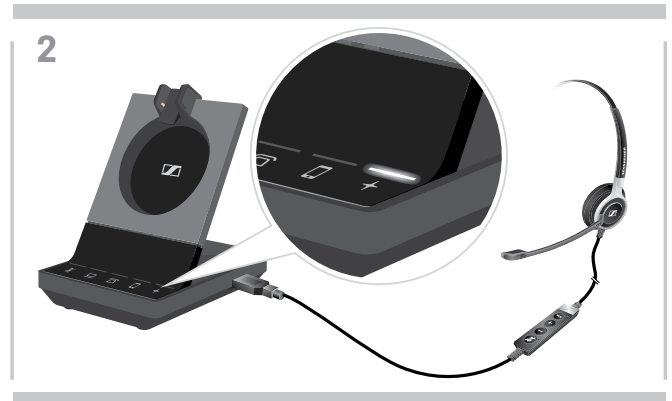

The LED + lights up white.

Connecting a speakerphone



To use an **external speaker with microphone** such as the Sennheiser speakerphone SP 10, SP 20 or SP 220:

▶ Connect your speakerphone to the USB socket of the base station.
The LED + lights up white.

If you want to recharge the SDW headset - while using the speakerphone:

▶ Ensure the headset is docked before you initiate the call **OR**
Double tap the icon + on the base station to transfer the call from the headset to the speakerphone.

Connecting an optional busy light

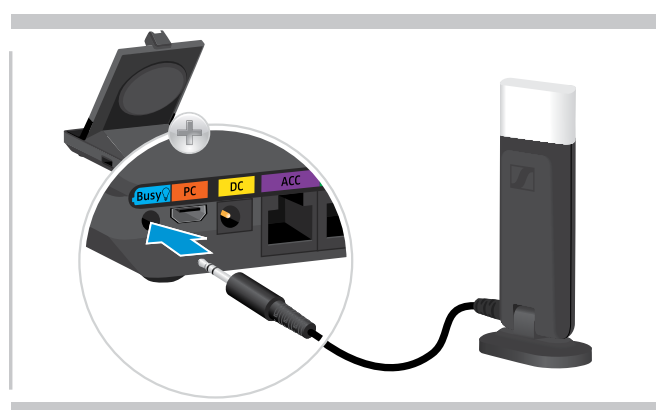

The busy light UI 10 BL signals to your colleagues if you are available or in a call. A flashing LED helps to recognize missed calls or received messages from your Softphone at a glance. The busy light UI 10 BL is available as an accessory.

▶ Connect the busy light to the Busy socket of the base station.
The LED of the busy light lights up while the base station is switched on (see page 6).

▶ Attach the busy light to your monitor or to your desk – if required (see UI 10 BL Quick Guide).

Assembling and wearing the headset

You can wear the headset either with the headband, the ear hook or the neckband.

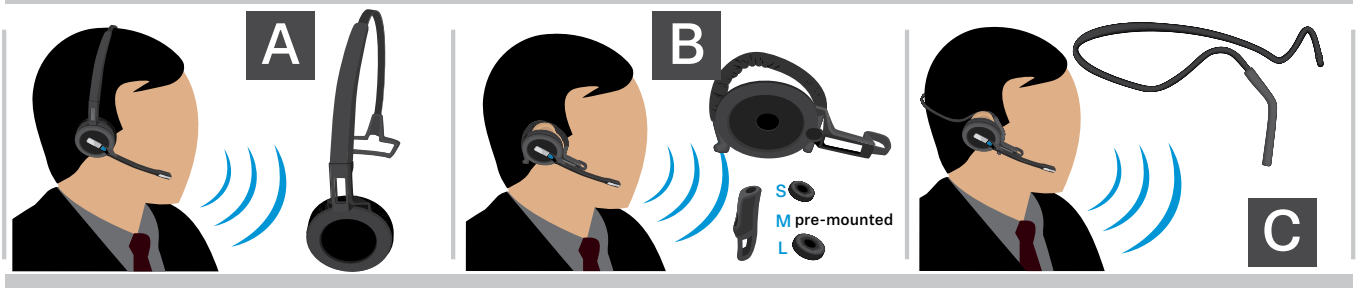

▷ Before assembly, remove the stickers showing where the charging pin should be inserted.

Using the headset with the headband

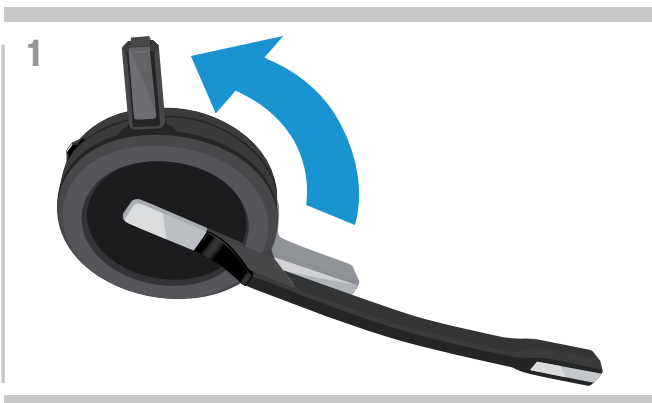

▷ Rotate the headset's charging pin away from the microphone boom.

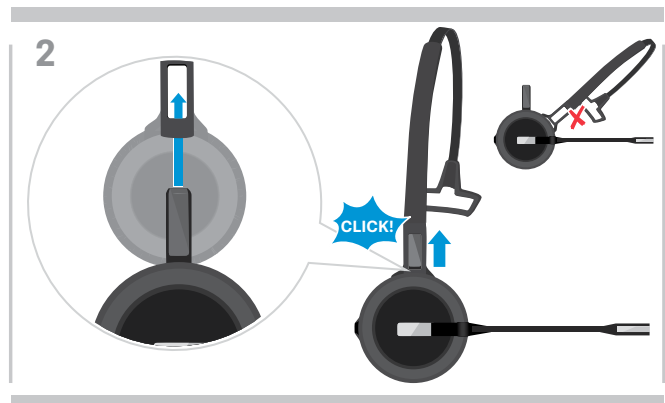

▷ Slide the charging pin into the holder of the headband.

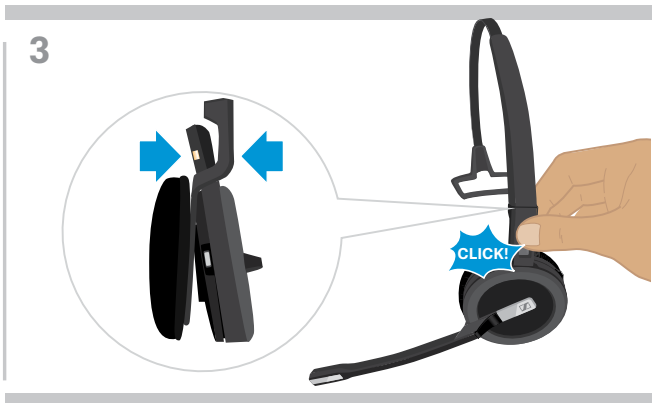

▷ Snap the charging pin into the headband.



▷ Snap the headset into the circular part of the headband.



▷ Rotate the microphone boom to change wearing side.

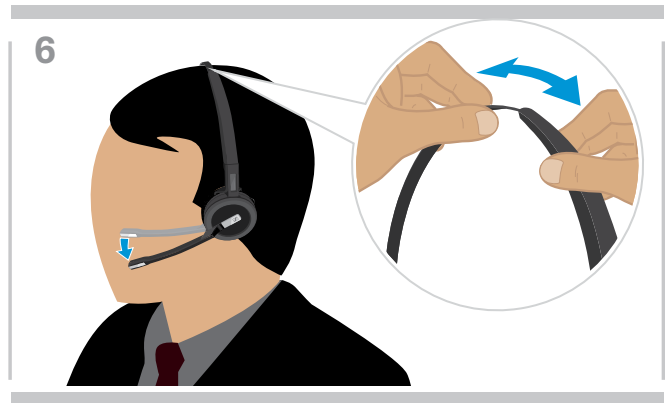

▷ Adjust the headset so that the ear pad rests comfortably on your right or left ear.

Using the headset with the ear hook

Assembling the ear hook and the headset

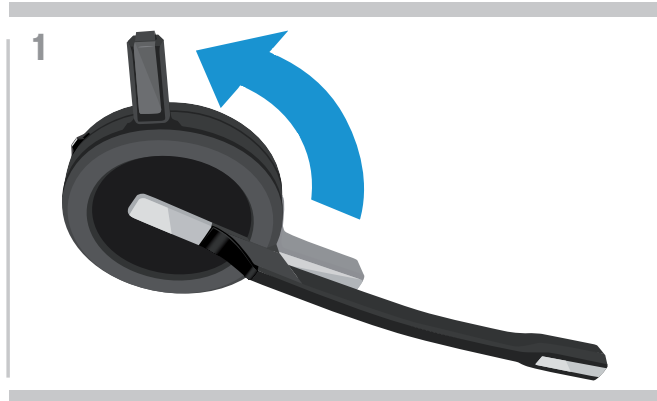

▷ Rotate the headset's charging pin away from the microphone boom.

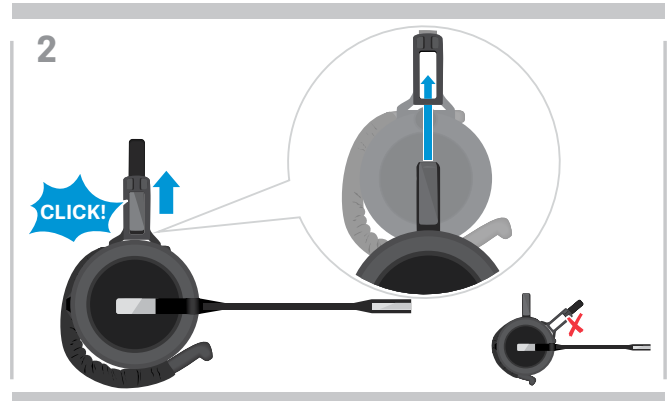

▷ Insert the charging pin into the holder of the wearing style adapter.

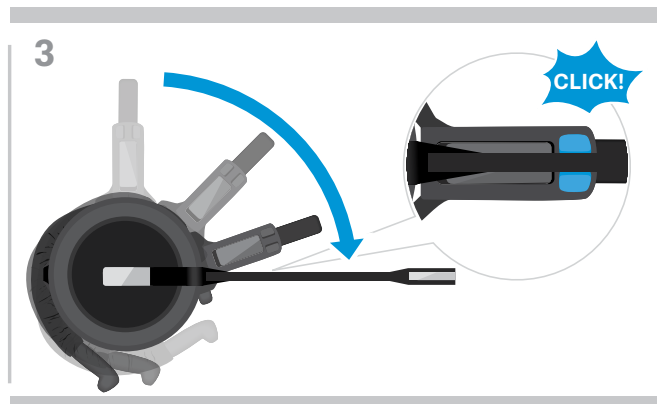

▷ Rotate the boomarm to snap it in the wearing style adapter.

Adjusting the ear hook for perfect wearing comfort

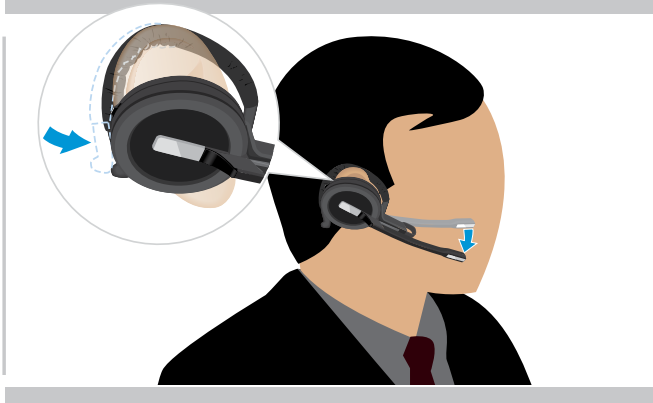

- ▷ Fit the ear hook around your ear with the ear bud placed in your ear.
- ▷ Bend the flexible ear hook so that the headset sits comfortably and securely on your ear.

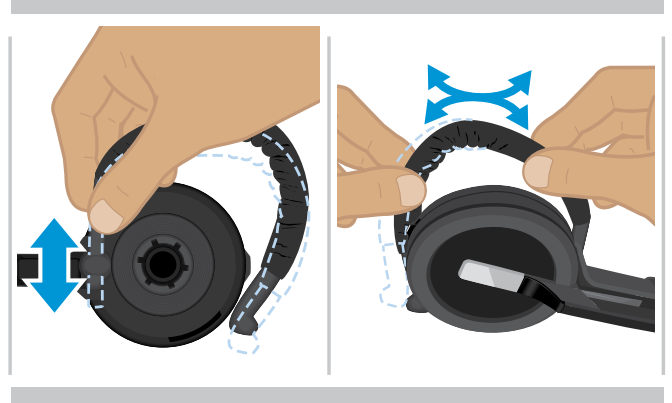

- ▷ Adjust the ear hook's height and shape.



- ▷ Change ear bud size for optimal fit – if required.

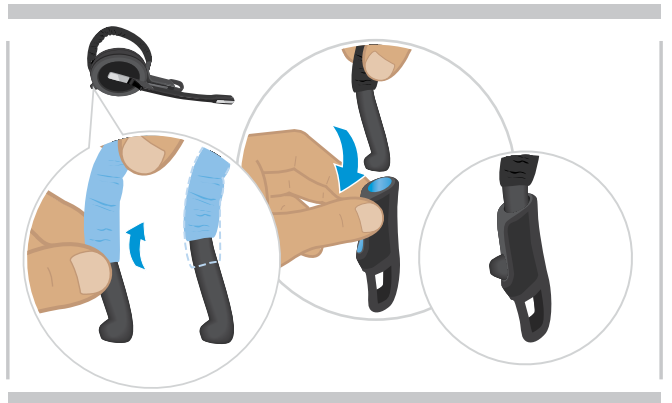

- ▷ Mount the ear hook stabilizer for an improved fit – if required.

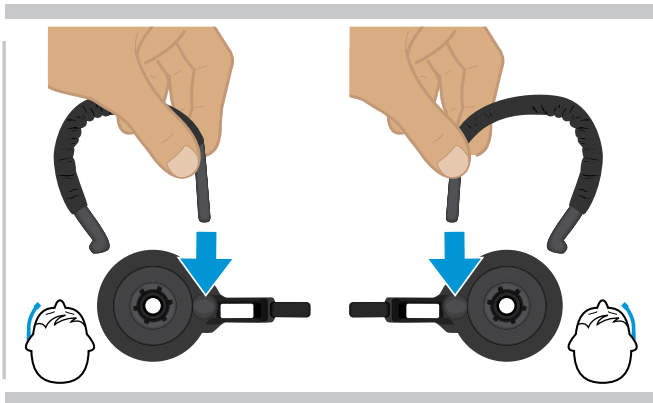

- ▷ Change wearing side – if required.

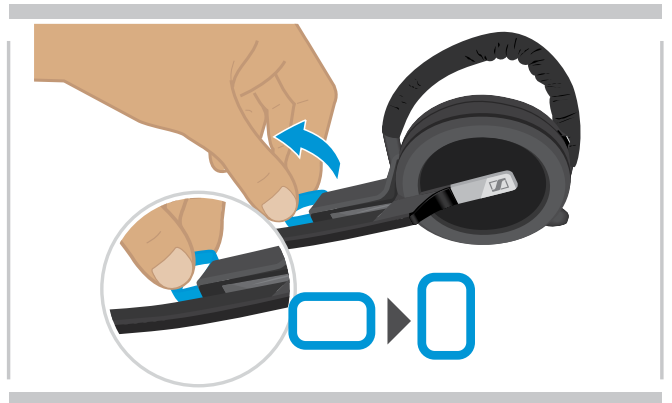

- ▷ Rotate the cheek spacer to increase or decrease the distance between the microphone and your mouth – if required.

Using the headset with the neckband

Assembling the neckband and the headset

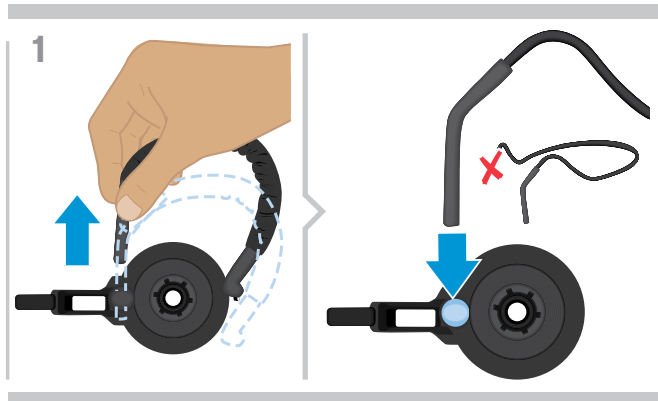

▷ Remove the ear hook from the wearing style adapter and insert the neckband instead. Make sure the inserted side has the holder mounted on the neckband.

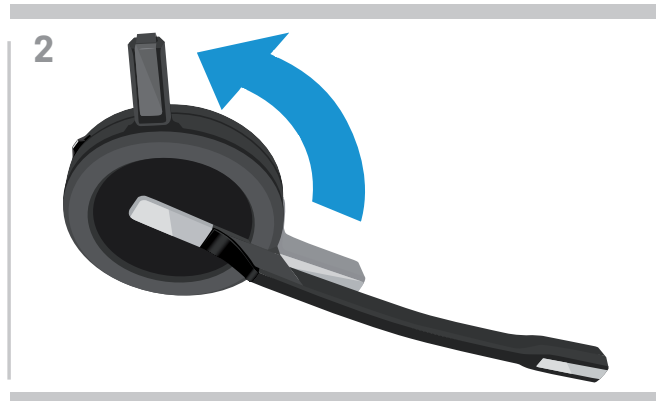

▷ Rotate the headset's charging pin away from the microphone boom.

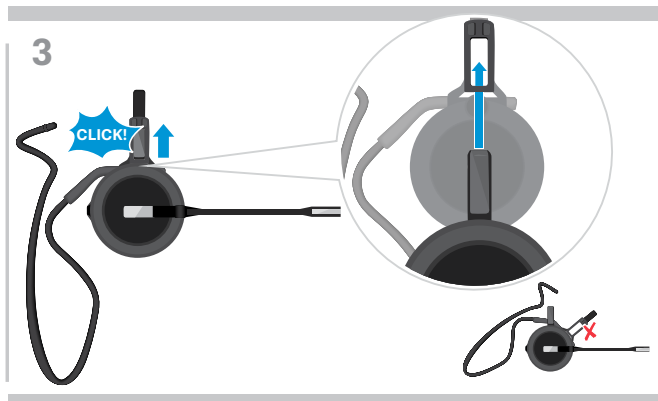

▷ Insert the charging pin into the holder of the wearing style adapter.

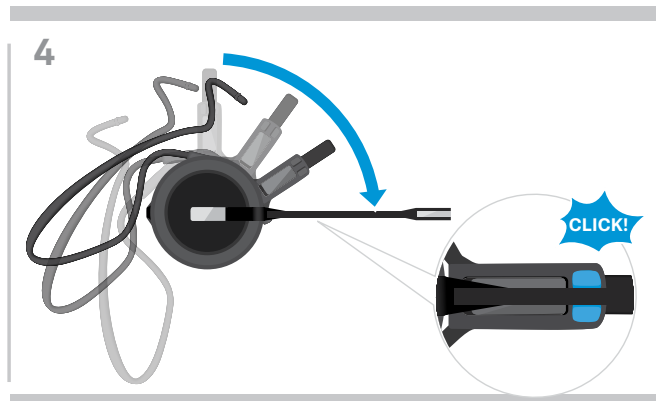

▷ Rotate the boomarm to snap it on the wearing style adapter like shown.

Adjusting the neckband for perfect wearing comfort

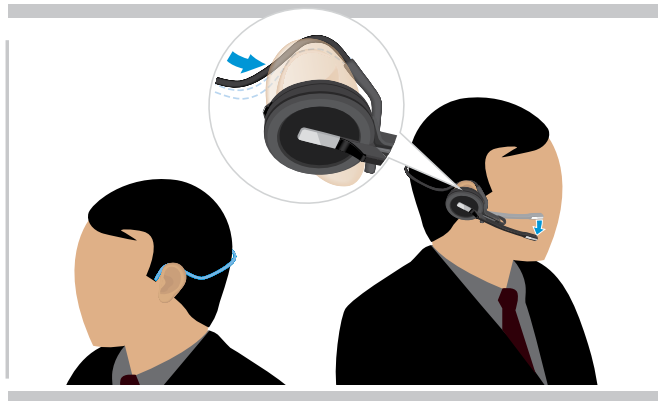

▷ Fit the neckband around your neck and both ears. Ensure that the ear bud is placed in your ear.

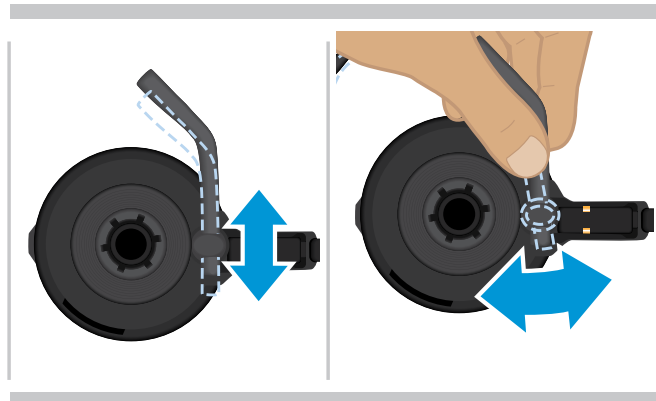

▷ Adjust the neckband's height and angle.



▷ Change ear bud size for optimal fit – if required.

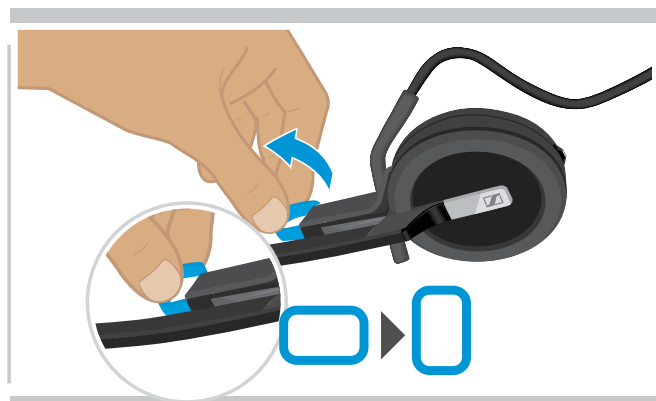

▷ Rotate the cheek spacer to increase or decrease the distance between the microphone and your mouth – if required.

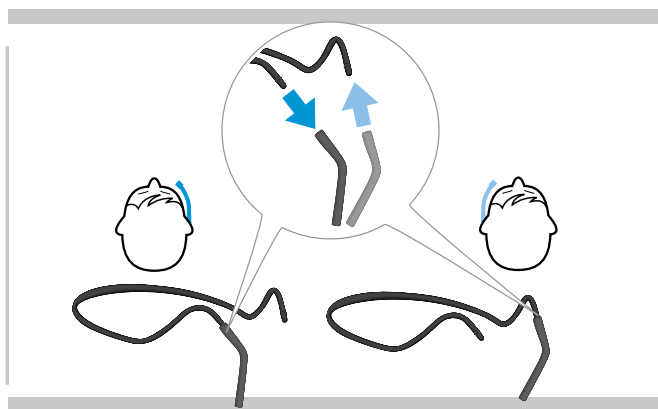

▷ Change wearing side – if required.

Detaching headband, ear hook or neckband

CAUTION

Improper handling can damage the product!

If the charging pin and microphone boom overlap while detaching, they can break.

- ▷ Rotate the charging pin as shown.

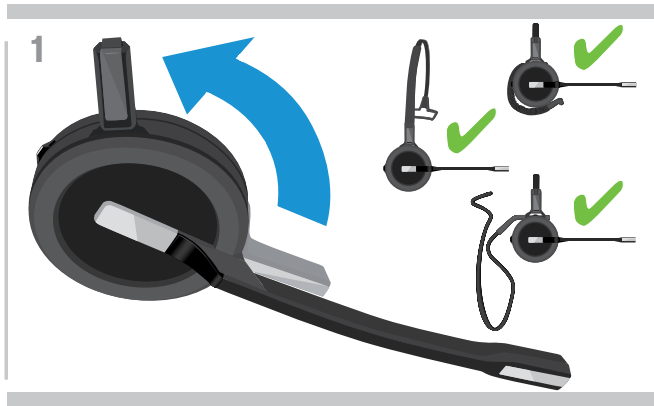

- ▷ Rotate the holder with the charging pin away from the microphone boom.

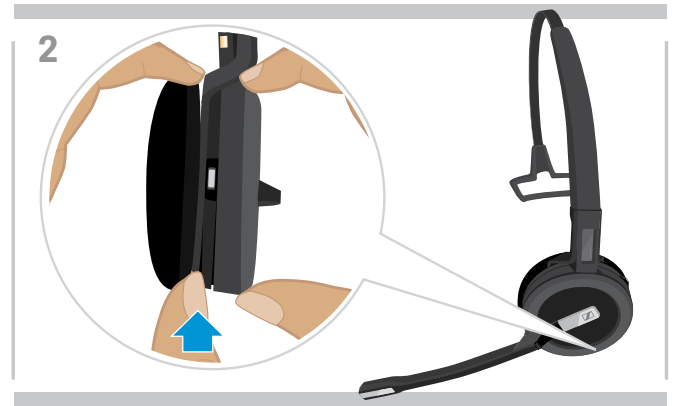

- ▷ Hold the headset with the one hand.
- ▷ Slide one finger of the other hand into the small recess on the headband or wearing style adapter.

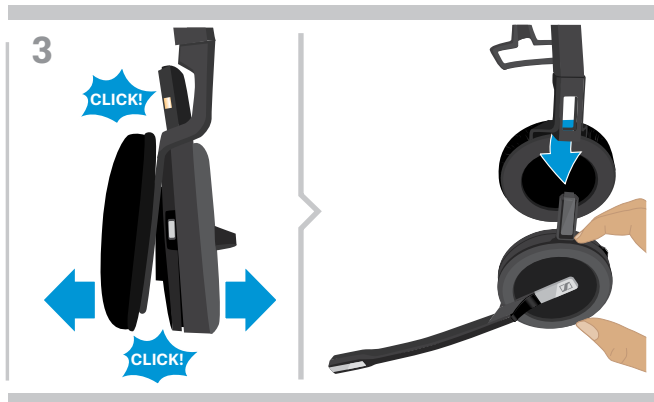



- ▷ Pull the two units apart from each other. The headset loosens and you hear a click.
- ▷ Remove the headset from the holder.

Labeling the headset

1 Name Plate Maker



www.sennheiser.com/name-plate-maker

 TYPE
 PRINT
 CUT



▷ Open the „Name Plate Maker“ under:
www.sennheiser.com/name-plate-maker.

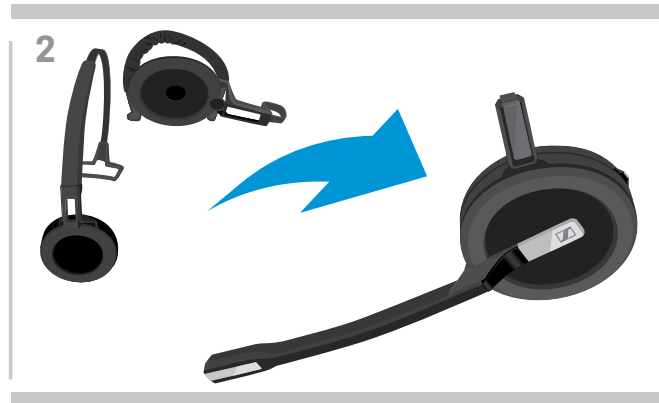

▷ Detach the headband or wearing style adapter from the headset (see previous chapter).

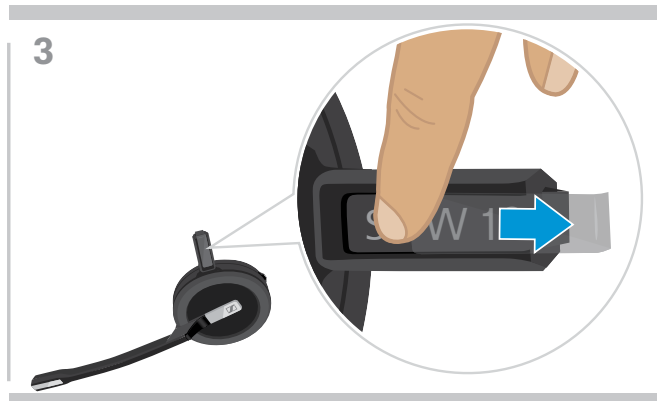

▷ Remove the cover.

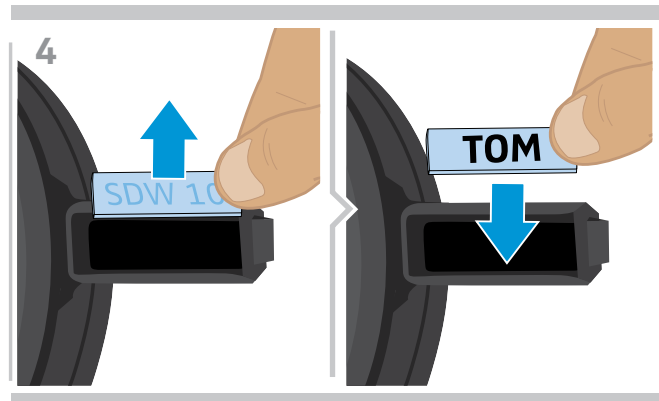

▷ Replace the name plate.

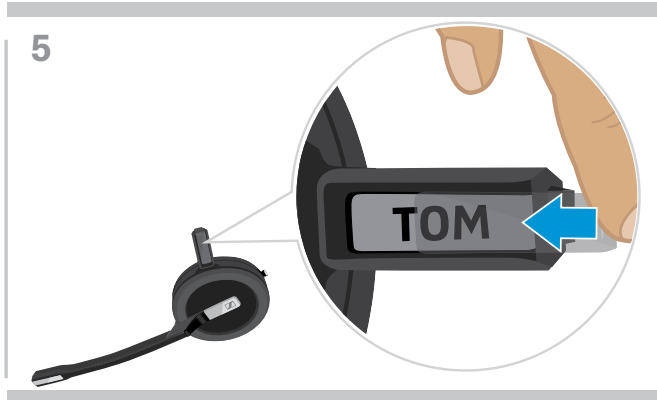

▷ Slide the cover in the holder.

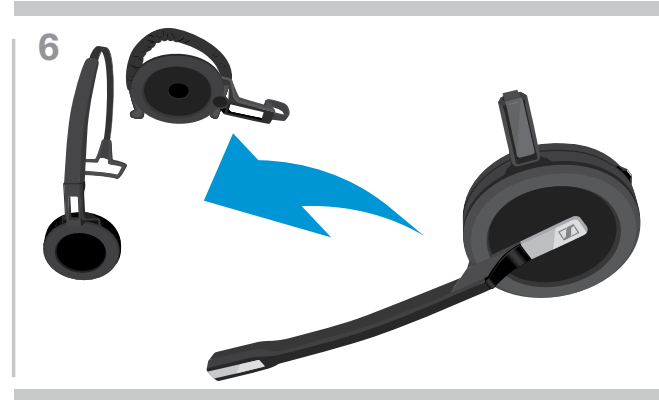

▷ Reassemble the headset with the headband or wearing style adapter (see previous chapter).

Configuring the headset system

Configuring the headset system using HeadSetup™ Pro or the DIP switches

You can adjust the headset system via the software [HeadSetup™ Pro](#) or the DIP switches on the base station. Changes in [HeadSetup™ Pro](#) overwrite the DIP switch settings.

[HeadSetup™ Pro](#) offers additional settings – marked with the adjacent icon in the following chapters. In addition to the settings described here, [HeadSetup™ Pro](#) offers further configurations – see options in the software.

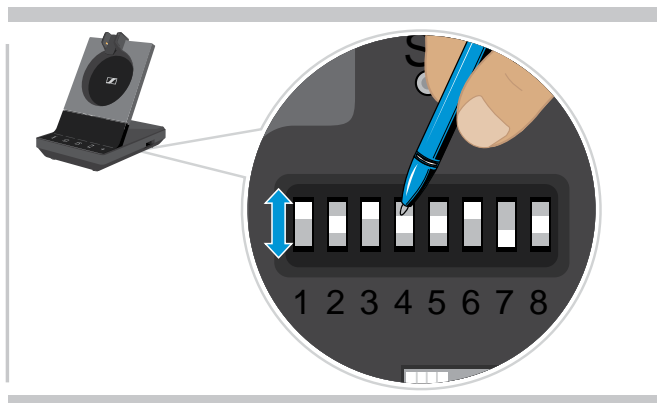

To configure the system via the DIP switches:

- ▶ Use a pointed object to set the DIP switches to the desired position. After a DIP switch is changed:
- ▶ Re-boot the system by disconnecting the power supply and USB cable shortly from the power.

To configure the system via [HeadSetup™ Pro](#):

- ▶ Connect the base station to your computer and install the required software (see page 11).
- ▶ Start [HeadSetup™ Pro](#).
- ▶ Click on “Settings” in the menu and choose your SDW 5000 device.
- ▶ Change to the desired values and save.

Configuring the desk phone – DIP switches 1 and 2 – SDW 5 BS only

If you do not have a desk phone with an EHS solution, the HSL 10 II can be used for remote call control.



Switch position	Function	Switch position	Function
 1 2 3 4 5 6 7 8	DHSG mode Call control with phones using DHSG standard	 1 2 3 4 5 6 7 8	Panasonic mode Call control with Panasonic phones
 1 2 3 4 5 6 7 8	Manual mode Manual operation* of handset or handset lifter HSL 10 II	 1 2 3 4 5 6 7 8	Auto link Wireless link between headset and base station established automatically
 1 2 3 4 5 6 7 8	OptiPoint mode Call control with OptiPoint phones	 1 2 3 4 5 6 7 8	MSH mode Call control with phones using MSH standard
 1 2 3 4 5 6 7 8	 1 2 3 4 5 6 7 8	 1 2 3 4 5 6 7 8	No assigned modes

* For undetectable phones without call control: Touch the icon to manually establish a link to the desk phone. A second touch will close the link and allows to operate calls on other audio sources (/).

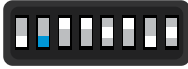

Enable/disable voice prompts – DIP switch 2 – SDW 3 BS only

Switch position	Function	Switch position	Function
 1 2 3 4 5 6 7 8	On Voice prompts enabled	 1 2 3 4 5 6 7 8	Off Voice prompts disabled, tones used instead

Adjusting the radio range – DIP switch 3

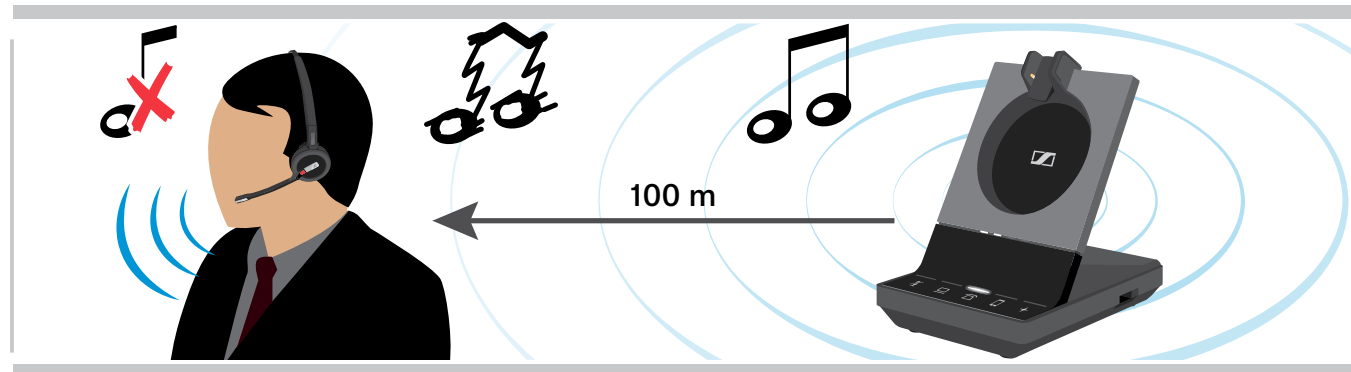



If many DECT systems are operated in a confined space, interference can occur. In this case, you should change the radio range on the DECT systems.

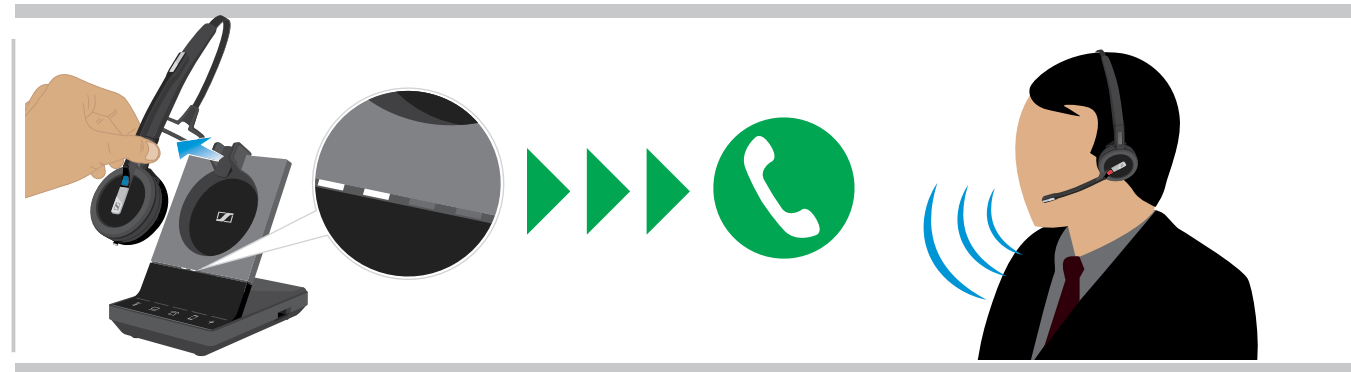

Switch position	Function	Switch position	Function
 1 2 3 4 5 6 7 8	Long range Up to 100 m indoors	 1 2 3 4 5 6 7 8	Short range Up to 10 m indoors; for minimal interference with other DECT devices in dense environments
 1 2 3 4 5 6 7 8	Medium range Up to 50 m indoors		





Adjust how the system handles incoming calls – DIP switch 4

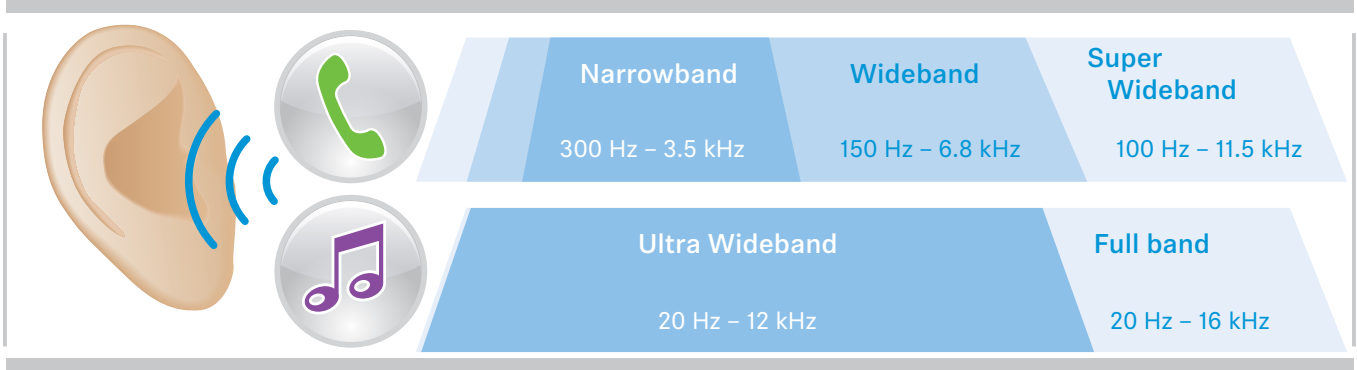

Switch position	Function	Switch position	Function
 1 2 3 4 5 6 7 8	Manual Hook Manual answering of calls via hook button on headset 	 1 2 3 4 5 6 7 8	Auto Hook Automatic answering of incoming calls when headset undocked
 1 2 3 4 5 6 7 8	Fast Link Manual answering and audio link to base station always open for fast response times		



Adjusting the audio quality – DIP switch 5

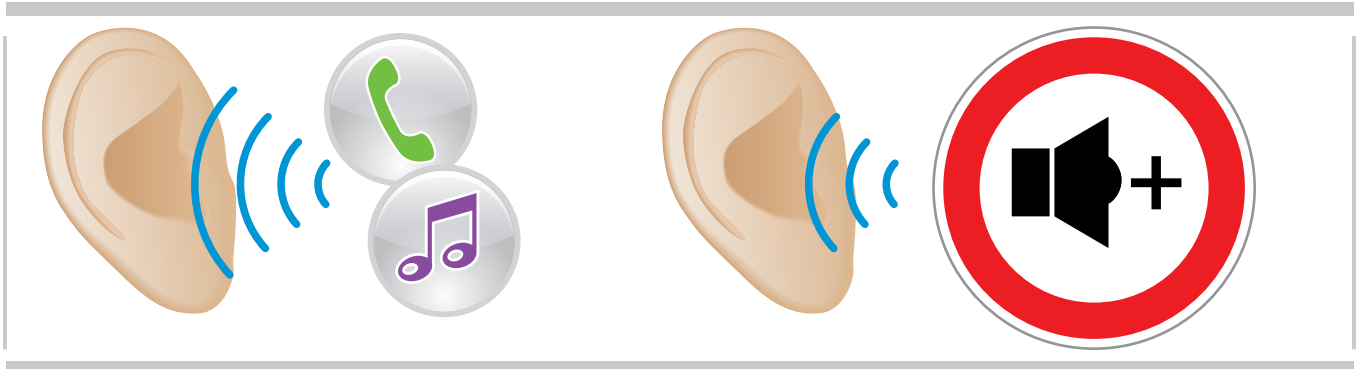

Switch position	Function	Switch position	Function
 1 2 3 4 5 6 7 8	Best <ul style="list-style-type: none"> calls: Super Wideband music: Full band 	 1 2 3 4 5 6 7 8	Good <ul style="list-style-type: none"> calls: Narrowband music: Ultra Wideband max battery and density performance
 1 2 3 4 5 6 7 8	Better <ul style="list-style-type: none"> calls: Wideband music: Ultra Wideband max talk time performance 		Better (Mode 2) like “Better” but optimized for max density performance
			Narrowband Desk Phone changes desk phone audio quality to narrowband, while enjoying a “better” sound with other devices

Limiting the volume – DIP switch 6



Switch position	Function	Switch position	Function
 1 2 3 4 5 6 7 8	off	 1 2 3 4 5 6 7 8	AU limiter Compliant with Directive AS/ACIF G616:2006
 1 2 3 4 5 6 7 8	EU/US limiter Compliant with Directive 2003/10/EC		

Adjusting the ring tone and ring tones volume of the base station – DIP switch 7 and 8

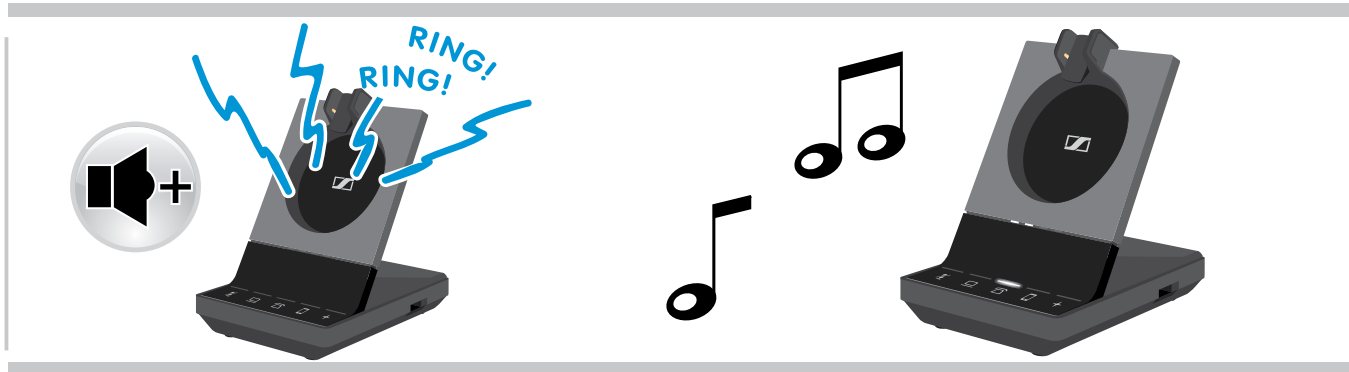

Switch position	Function	Switch position	Function
<p>1 2 3 4 5 6 7 8</p>	<p>Ringing volume High</p>	<p>1 2 3 4 5 6 7 8</p>	<p>Ring tone 1 Active</p>
<p>1 2 3 4 5 6 7 8</p>	<p>Ringing volume Low</p>	<p>1 2 3 4 5 6 7 8</p>	<p>Ring tone 2 Active</p>
<p>1 2 3 4 5 6 7 8</p>	<p>Ringing volume Off</p>	<p>1 2 3 4 5 6 7 8</p>	<p>Ring tone 3 Active</p>
	<p>Ringing volume</p> <ul style="list-style-type: none"> • Very low • Medium 		

Adjusting the audio signal for desk phones using the ABC switch – SDW 5 BS only

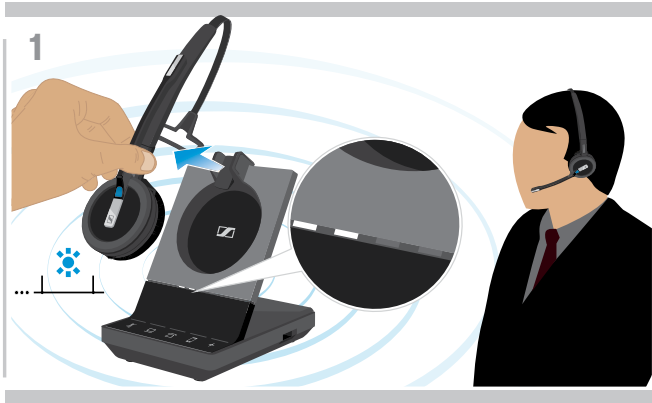

1 Put on the headset.



2 Press the button  on the base station.



3 Lift the handset.
You hear a dial tone.

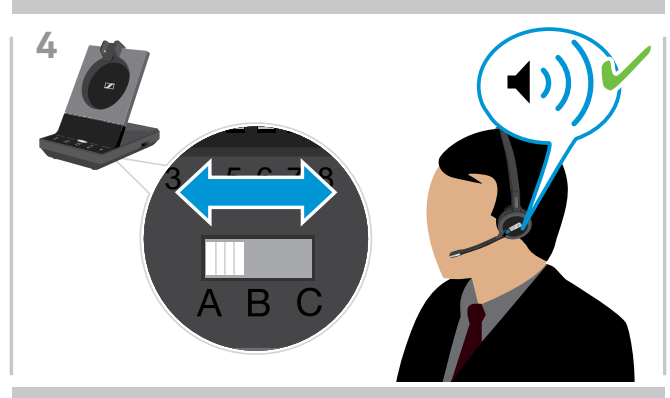

4 Set the ABC switch to the position A, B or C so that you can hear a clear dial tone in the headset.

Adjusting the transmission volume

Adjusting the microphone volume for the connected desk phone – SDW 5 BS only

By default, the microphone volume control is set to 4. This setting is suitable for most telephones.



1 Make a call to someone who will help you find the correct sensitivity setting for your microphone (see page 31).



2 Turn the microphone volume control so that the other party can hear you at a comfortable level.

Adjusting the microphone volume for the connected computer

- ▷ Activate the option “Automatically adjust microphone sensitivity” in the settings of your softphone – if available.
- ▷ Adjust the microphone sensitivity via your operating system, so that the other party can hear you at a comfortable level (see Help function of your operating system).

Setting up and using the headset

Adjusting the volume



CAUTION

Hearing damage due to high volumes!

Listening at high volume levels for long periods can lead to permanent hearing defects.

- ▷ Set the volume to a low level before putting on the headset.
- ▷ Do not continuously expose yourself to high volumes.

Adjusting the volume of the audio signal, the ring tone and the voice prompts

You can adjust two independent volume settings for the headset:

- speaker volume: can be adjusted during an active call or during music reproduction,
- volume for the ring tone, the beeps and the voice prompts: can be adjusted in idle mode (no active call or music reproduction)

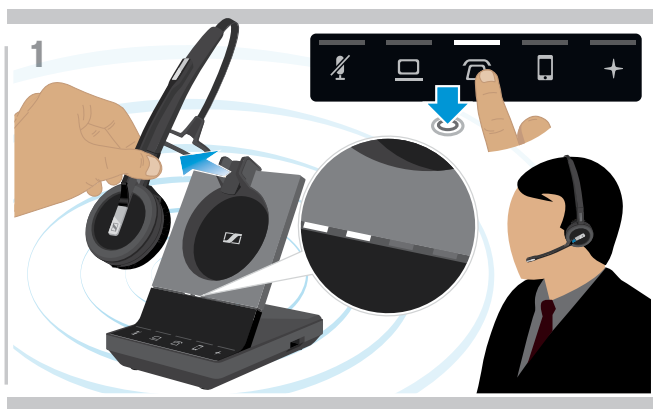

- 1
- ▷ Put on the headset.
- ▷ Choose your audio source.
The corresponding LED lights up.

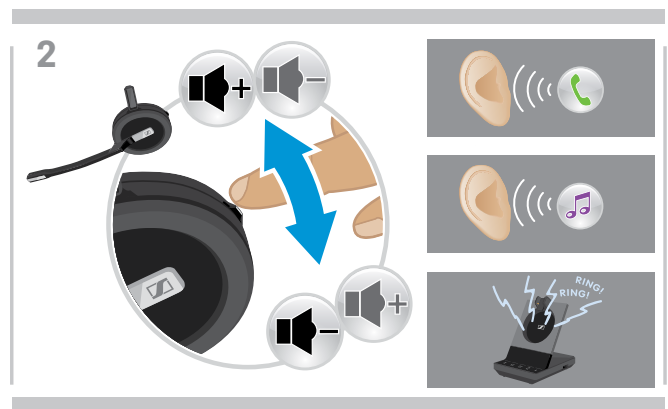

- 2
- ▷ Push the Mute & Volume button up or down to adjust the volume.

When the minimum or maximum volume is reached, the voice prompt **“Volume min”** or **“Volume max”** is announced in the headset. When the voice prompts are disabled, you hear a beep in the headset instead.

Swapping the direction of the volume buttons

You can change the direction of the Volume button's up/down function if, for example, you want to wear the headset on the other ear. If the motion sensor is enabled, the volume keys automatically swap direction when you change the wearing side.

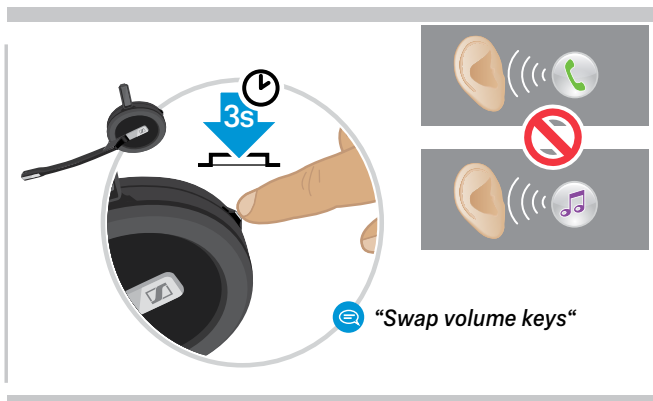

- ▷ Press and hold the Mute & Volume button (no active call or music reproduction):
The direction of the button's volume up/down function is changed. The voice prompt **“Swap volume keys”** is announced in the headset.





You can also change this settings via HeadSetup™ Pro.

Muting the headset's microphone



Muting the microphone



- ▶ Press the Mute button on the headset **OR** Touch the Mute button  on the base station. The microphone is muted and the LED  lights up red. The voice prompt **"Mute on"** is announced.

Unmuting the microphone



- ▶ Press the Mute button on the headset **OR** Touch the Mute button  on the base station. The muting is canceled and the LED  switches off. The voice prompt **"Mute off"** is announced.

Enabling/disabling voice prompts

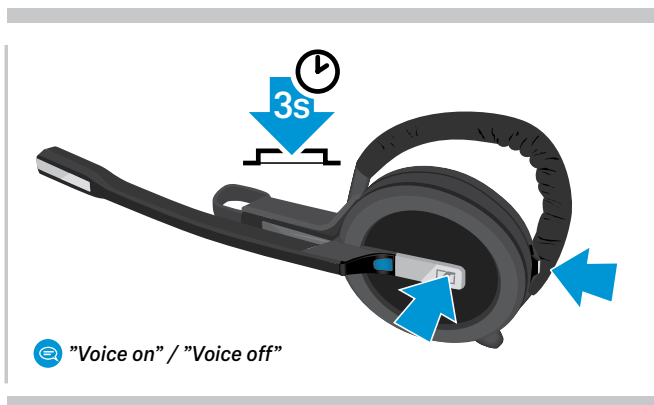

- ▶ Take the headset out of the base station.
- ▶ Simultaneously press and hold the hook and mute button for 3 seconds. The voice prompts are now activated/deactivated and the voice prompt **"Voice on"** or **"Voice off"** is announced in the headset. If the voice prompts are deactivated, the headset emits beeps.

Verifying battery life

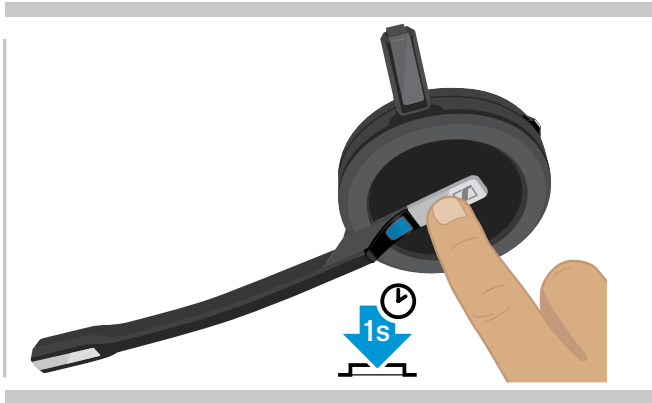

You can retrieve information on the remaining battery life at any time except when you are on a call or listening to music:

- ▶ Press the hook button for 1 second.
The remaining battery life is announced.

It is also possible to verify the remaining headset battery life at any time via the base station battery LEDs.

Information announced

“More than eighty percent battery left”

“More than sixty percent battery left”

“More than forty percent battery left”

“More than twenty percent battery left”

“Less than twenty percent battery left”

Remaining battery life

> 80%

> 60%

> 40%

> 20%

< 20%

„Recharge headset“ 

less than 15 minutes talk time; automatic voice prompt

- ▶ Recharge headset (see page 43).

If you leave the DECT or Bluetooth range



In office buildings, the range between DECT headset and base station is up to 100 m. Further information on how to adjust radio range is given on page 24).

The range between a Bluetooth headset and base station or between the mobile phone and the base station/dongle is device dependent.

If the audio quality deteriorates during a call or the link breaks down completely, the voice prompt **“device disconnected”** is announced in the headset. The LED on the headset is off and the LED + on the base station lights up red.



- ▶ Re-enter the radio range of the base station to resume the call.

If your softphone supports call control, the call will automatically be ended 60 seconds after leaving the radio range.

Making calls using the headset system

In the following chapters the most important functions of the connected devices will be explained. Some functions depend on the configuration of the base station (see page 23).

For information on how to set up a teleconference combining multiple phone calls or headsets see chapter “Setting up conference call” on page 37.

If the optional UI 10 BL is connected (see page 15) the current state will be indicated by the busy light (see page 6).

Preparing calls - initial settings



Call control – manage calls directly via the headset:

- ▷ Visit our website at www.sennheiser.com and check whether your softphone is supported.
- ▷ Install our free software to enable call control support – if required.



- ▷ Ensure your BTD 800 USB dongle is paired and connected to your mobile phone (see page 12).

Selecting audio source – fixed line phone/ computer/ mobile phone







- ▷ Touch the icon of the desired audio source on your base station ☎/💻/📱.
- The chosen audio source is in focus and the LED lights up white.

If for example ☎ is in focus, press the hook button (or touch the icon ☎ again) to initiate a call via your fixed line phone – depending on the settings. The fixed line phone will remain your default audio source for outgoing calls until you change it.

Making a call



- ▷ Put on the headset.
- ▷ Press the hook button on the headset **OR** touch the icon on your base station to:
 - Computer : launch your softphone
 - Desk phone : activate the dial tone*
 - Mobile phone : initiate voice assistant
- ▷ Dial the desired number or choose your contact
The connection is established. The base station LED  lights up blue.

* For undetectable phones without call control (Manual mode, see page 23):

- ▷ Touch the icon  to manually establish a link to the desk phone. A second touch will close the link and allows to operate calls on other audio sources (/).

Accepting/rejecting a call

You hear a ringing in the headset, on the base station*, desk phone* or mobile phone* (*if enabled).
The base station LED  flashes blue.



Accept a call*

- ▷ Accept the call via the audio source **OR** Press the hook button on the headset **OR** Touch the icon  of the flashing LED.
The connection is established. The LED stops flashing and is fixed blue.

 While the SDW headset is docked for charging, the call can be accepted via the connected Bluetooth/USB headset or speakerphone.

*For automatic answering functionality, enable “Auto Hook” (see page 24) or motion sensor (see page 42).

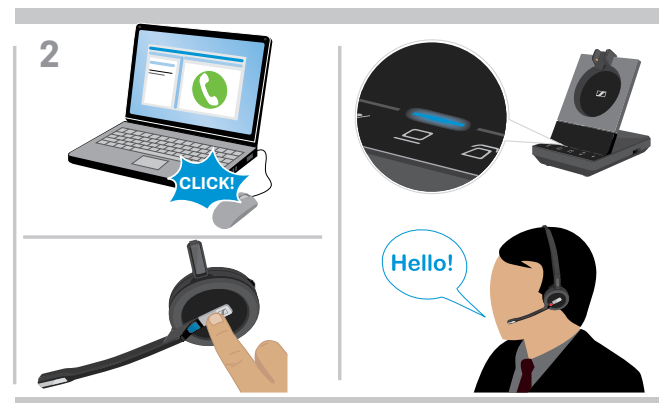

Reject a call

- ▷ Press the icon  of the flashing LED for 1 second **OR** Press the hook button on the headset for 1 second.
The voice prompt “**Call rejected**” is announced. The LED stops flashing and is fixed white.

Transferring calls to connected devices

Transferring the call to the optional Bluetooth/USB headset or speakerphone

To transfer an active call, e. g. if the headset battery is almost flat:

- ▶ Double tap the icon + on the base station.
The call is transferred to the Bluetooth/ USB headset or speakerphone.

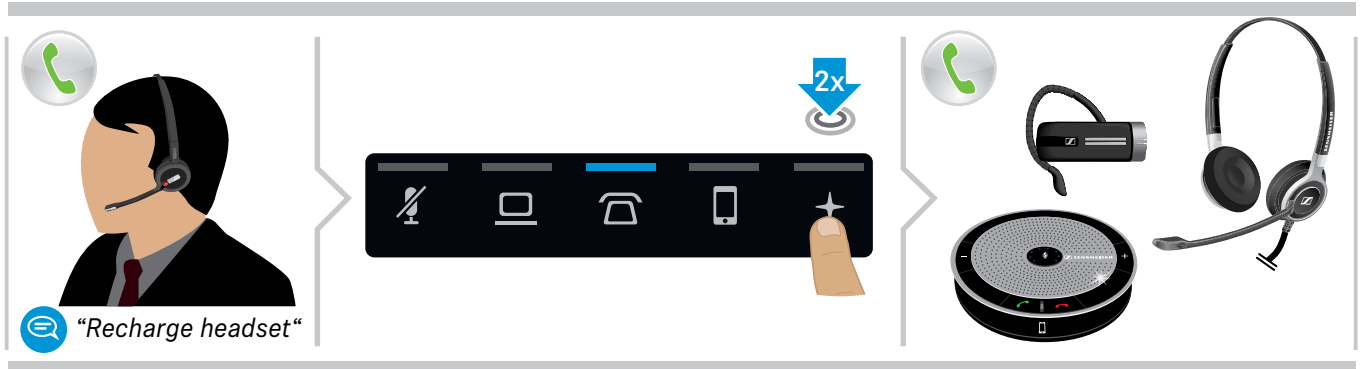

To switch an active call back to the SDW headset:

- ▶ Undock the SDW headset from the base station.
The call is automatically transferred to the SDW headset.

If the SDW headset is already undocked from the base station:

- ▶ Double tap the icon + on the base station.
The call is transferred to the SDW headset.

Transferring a softphone call to the mobile phone – “Skype for Business” only

- ▶ Set up your mobile phone number in the “Skype for Business” options menu. For more information visit the “Skype for Business” support website.
- ▶ Touch the icon + on the base station for 1 second to transfer the call to your mobile phone.

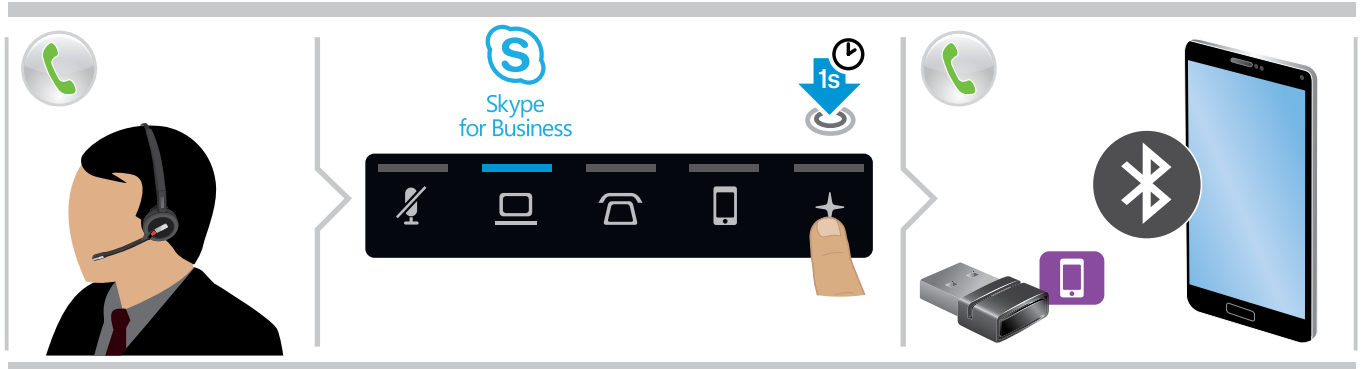

Ending a call



- ▷ End the call via the audio source. **OR**
- ▷ Place the headset into the charging cradle of the base station **OR**
Press the hook button on the headset **OR**
Touch the icon on the base station.

The call is ended. The base station LED lights up white. If the other party hangs up, your audio source and your headset become automatically ready to receive the next call.



Redialing



- ▷ Double tap the corresponding icon on the base station **OR** the hook button on the headset.

		Redials the last number "Redialing"
		Cancels redialing

Managing multiple calls - two calls from two audio sources



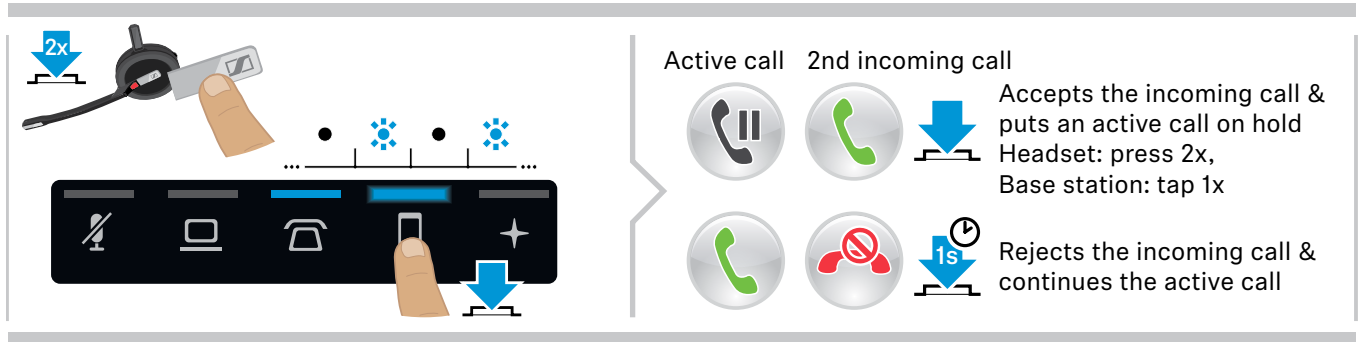

Accepting/rejecting a second call

If you receive a call on a second device while you are in an active call, the corresponding LED    flashes.



- ▶ Touch the icon    on the base station corresponding to the flashing LED
- OR double tap the headset's hook button:









The diagram illustrates two methods for managing multiple calls. On the left, a hand is shown double-tapping the headset's hook button, indicated by a '2x' icon. Below it, a base station control panel shows a hand tapping the mobile phone icon, with a blue arrow pointing to the corresponding LED. On the right, a legend defines the actions:

Active call	2nd incoming call	Action
		Accepts the incoming call & puts an active call on hold Headset: press 2x, Base station: tap 1x
		Rejects the incoming call & continues the active call

Ending the active and accepting the incoming call

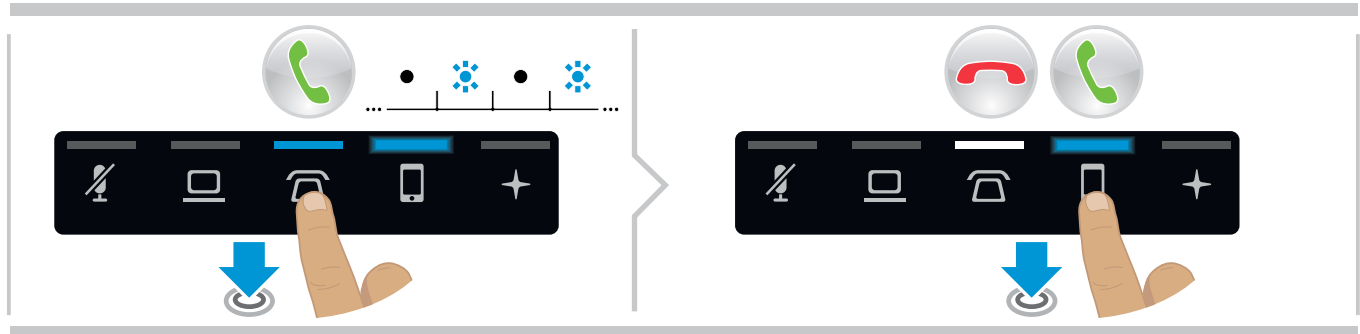

If you receive a call on a second device while you are in an active call, the corresponding LED    flashes.

- ▶ Touch the icon    of the blue lit-up LED on the base station to end the active call.
- ▶ Touch the icon    corresponding to the flashing LED to accept the call.





The diagram shows two steps for managing multiple calls. On the left, a hand taps the laptop icon on the base station control panel, with a blue arrow pointing to the corresponding LED. On the right, a hand taps the mobile phone icon on the base station control panel, with a blue arrow pointing to the corresponding LED. Above the panels, call status icons are shown: a green phone icon, a red phone icon, and a green phone icon.

Merging a held call into an active call – Mini conference

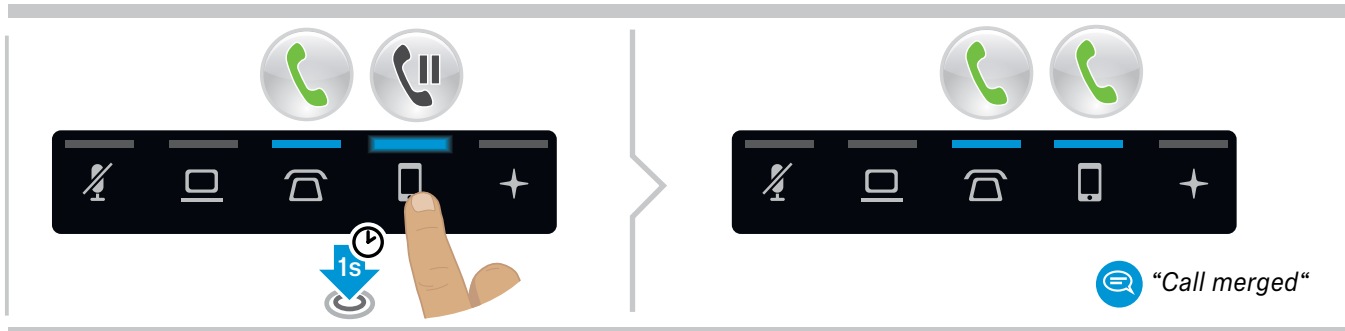
- ▶ Touch the icon / of the held call for 1 second (LED stops flashing when merged).





Unmerging a call from a Mini conference and put in on hold

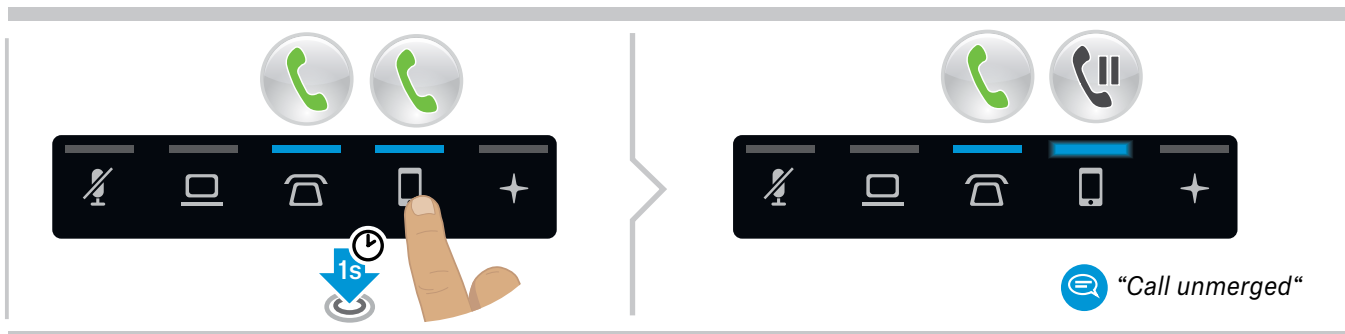

- ▶ Touch the icon / of the audio source with the call you want to put on hold for 1 second (LED of unmerged call starts flashing).



Toggling between active and held call

- ▶ Tap the icon / of the held call (flashing LED) OR double tap the headset's hook button.

If both calls are on the same source:

- ▶ Double tap the icon / of the active call to toggle between the calls.

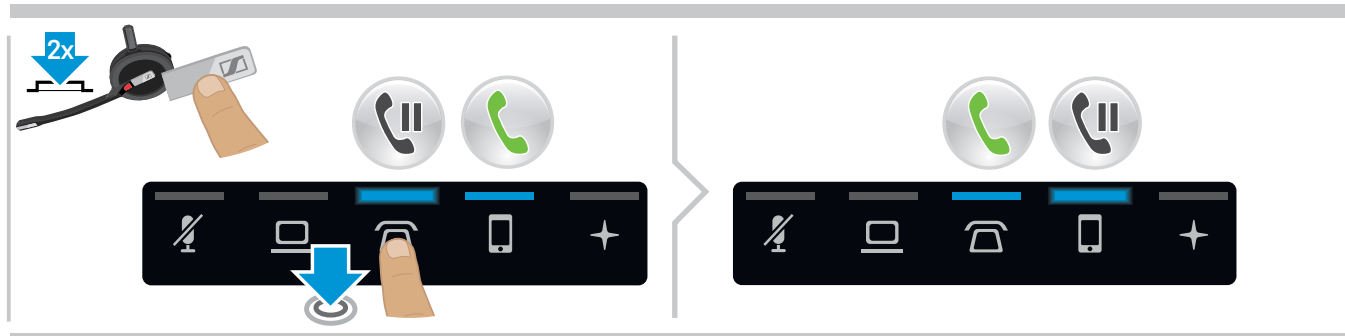

Setting up conference call

With one base station, you can:

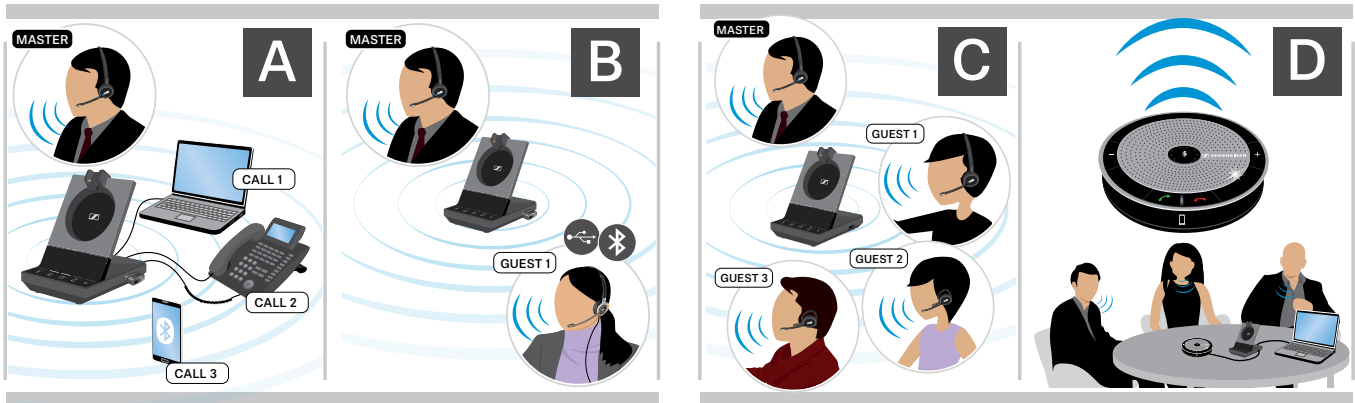

- **A** merge up to three calls from the **connected audio sources** into one teleconference (see previous chapter),
- **B** set up a **small conference** with an SDW 5000 headset and an additional Sennheiser USB or Bluetooth headset,
- **C** a **large conference** with up to four SDW 5000 headsets,
- **D** set up a conference with a Sennheiser **USB speakerphone** (e. g. SP 20).

All conferencing options can be combined. It is for example possible to set up a large conference with 2 audio sources merged, where multiple SDW headsets and one Bluetooth or USB device is connected.

Setting up a small conference via USB or Bluetooth headset

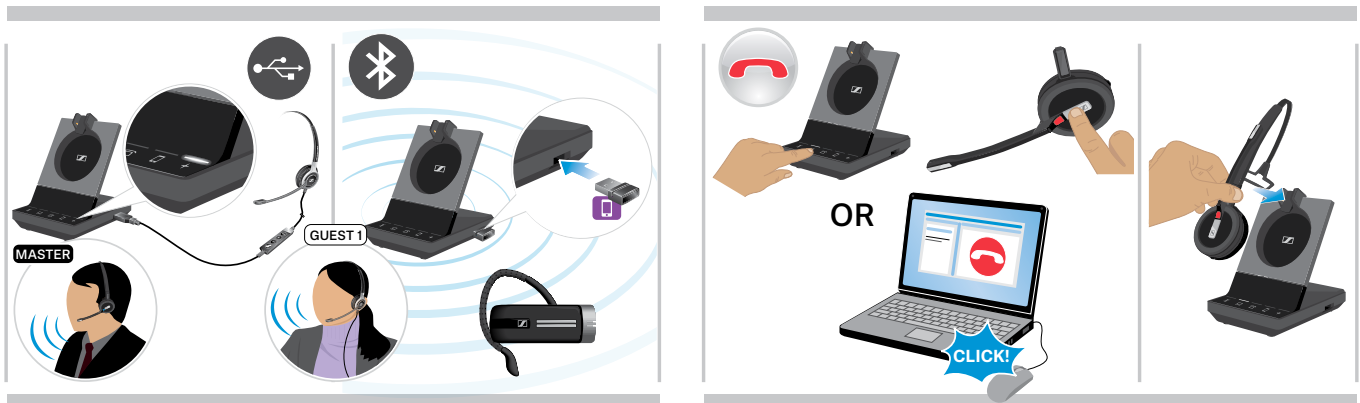

- ▷ Put on the MASTER headset.
- ▷ Connect your USB or Bluetooth headset (see page 14/15) with the base station. The LED + lights up white.
- ▷ Press the hook button on the MASTER headset within 10 seconds to add the GUEST headset. The voice prompt **“Conference pairing successful”** is announced in the GUEST headset.
- ▷ Call the other party (see page 31).

To **end the call** but **keep the conference**:

- ▷ End the call via your audio source, the base station or the MASTER headset. All conference participants remain connected and a new call can be initiated with them.

To **end the call and the conference**:

- ▷ End the call via your audio source, the base station or the MASTER headset.
- ▷ Place the MASTER headset in the magnetic holder of the base station to disconnect all conference participants.

Setting up a large conference with up to 4 SDW series headsets

The headset system allows you to make a conference call with up to 4 SDW 5000 headsets. The first paired headset (MASTER) is used to control the call.



If you want to use a new MASTER headset:

- ▷ Place the headset into the base station. The Headset LED alternately flashes blue/red until a link to the base station is established. The Headset LED flashes blue twice.



- ▷ Put on the MASTER headset.
- ▷ Change audio source – if required (see page 31).

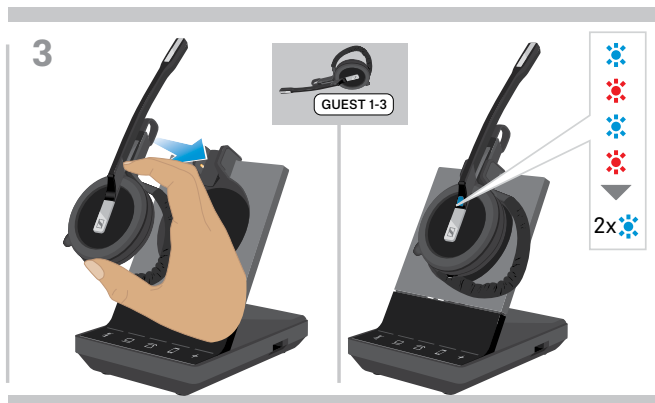

- ▷ Press and hold the Mute & Volume button while placing the GUEST headset into the base station of the MASTER headset. The Headset LED alternately flashes blue/red until a link to the base station is established. The Headset LED flashes blue twice. The voice prompt **“Conference pairing”** is announced in the MASTER headset.

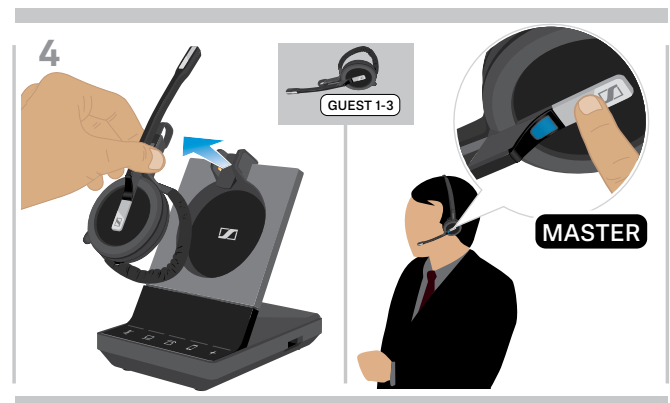

- ▷ Take the GUEST headset out of the base station.
- ▷ To add the GUEST headset to the conference call, press the hook button on the MASTER headset within 10 seconds. The voice prompt **“Conference pairing successful”** is announced in the GUEST headset.
- ▷ Add additional GUEST headsets – if required.



- ▶ Call the other party.
The LED lights up blue on the base station.
The GUEST can leave the call by pressing the hook button on the GUEST headset.

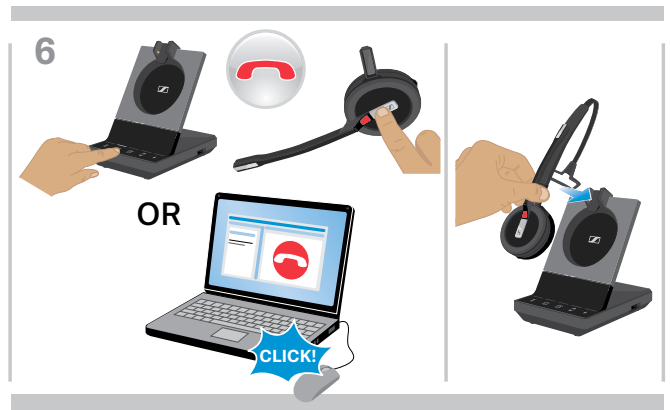

To **end the call** but **keep the conference**:

- ▶ End the call via your audio source, the base station or the MASTER headset.
A new call can now be initiated with the same conference participants.

To **end the call and the conference**:

- ▶ End the call via your audio source, the base station or the MASTER headset.
- ▶ Place the MASTER headset in the magnetic holder of the base station to end the conference.

i “easy pairing” To subsequently use the GUEST headset with other base stations, place the GUEST headsets into the other base stations. The Headset LED alternately flashes blue/red until a link is established.

Adding a GUEST headset during a call with the MASTER headset

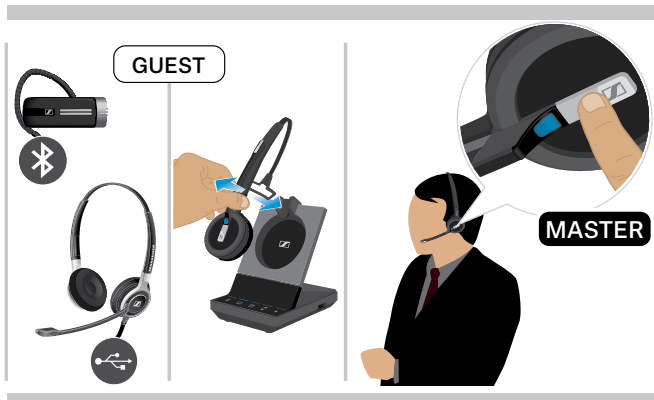

- ▶ Connect your USB or Bluetooth headset (see page 14/15) with the base station **OR** Dock and undock the GUEST SDW 5000 headset (no need to press the Mute button).
- ▶ Press the hook button on the MASTER headset within 10 seconds to add the GUEST headset.
The voice prompt “*Conference pairing successful*” is announced.
The GUEST can leave the conference by ending the call on the GUEST headset.

Making a conference call with a Sennheiser USB speakerphone

If the SDW headset is docked in the base station the speakerphone becomes the MASTER. If the SDW headset is undocked, the speakerphone works as GUEST.



- ▶ Connect the speakerphone to the USB socket on the base station.
The LED + lights up white.
- ▶ Choose your audio source (s) (see page 31).
- ▶ Call the other party.
Depending on the audio source the LED lights up blue on the base station.
- ▶ End the call via your audio source or speakerphone and unplug the speakerphone from the USB socket.

Using the dictation mode

Recording desk or mobile phone calls with the Dictation mode

SDW 5000 offers a Dictation mode which allows recording of phone calls via an application on your computer. In this mode the microphone is always open towards the computer, so that a call on the desk or mobile phone can be recorded.

To switch the Dictation mode on:

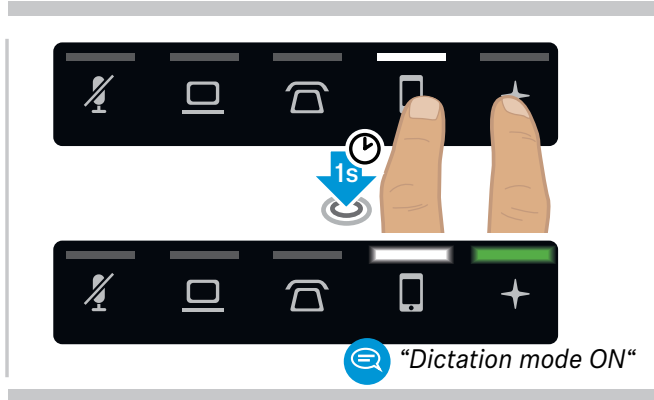

- ▶ Make sure, that the system is in idle mode (no active call or music).
- ▶ Touch the icon ☎ or 📱 and the + on the base station simultaneously for 1 second. The Dictation mode is switched on. The voice prompt **“Dictation mode ON”** is announced. The base station LED + lights up green and the selected audio source LED ☎ or 📱 lights up white.

The Dictation mode will stay on if the headset is docked.

Calls can only be received and made from the selected audio source (desk or mobile phone). Other audio sources are inactive.

If you receive a call on an inactive source:

- ▶ Switch the Dictaphone mode off and accept the call.

Recording computer's audio

You can record calls or any audio signal directly via a computer application. Listening to recordings on a computer is only possible, while Dictation mode for phones is switched off (see above).

To switch the Dictation mode off:

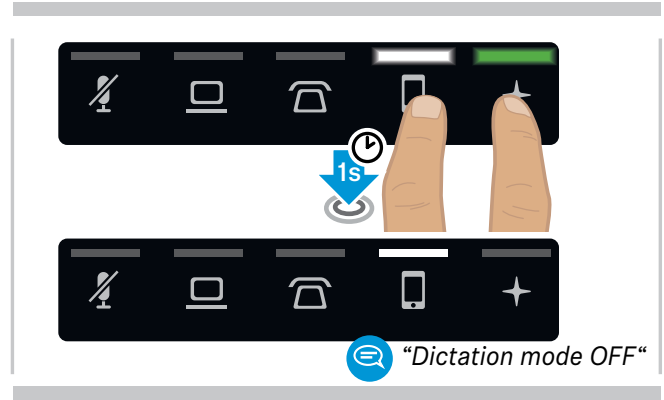

- ▶ Touch the icon ☎ or 📱 (LED white) and the + on the base station simultaneously for 1 second. The Dictation mode is switched off. The voice prompt **“Dictation mode OFF”** is announced. The base station LED + switches off.

Dictation mode will also be switched off if the base station is powered off or re-booted.



Listening to music using the headset

You can listen to music from your computer or mobile device.

If you use the Bluetooth dongle BTD 800 with a mobile phone:

- ▶ Activate Bluetooth on your mobile phone.



- ▶ Touch the  or  icon.
The corresponding LED lights up white.





- ▶ Put on the headset.
- ▶ Play the music on your audio source.
The headset LED and the LED  on the base station light up purple.

 If you receive and accept a call, the music is paused and restarts after the call (if the music player supports this feature).





* The LED is off per default and can be enabled via HeadSetup™ Pro.





Plays the track





Pauses the track



Using the motion sensor

The headset is equipped with a motion sensor that registers when the headset is put in or out of rest position.

Enabling/disabling the motion sensor



- ▶ Put on the headset and place the ear cup on the left ear.

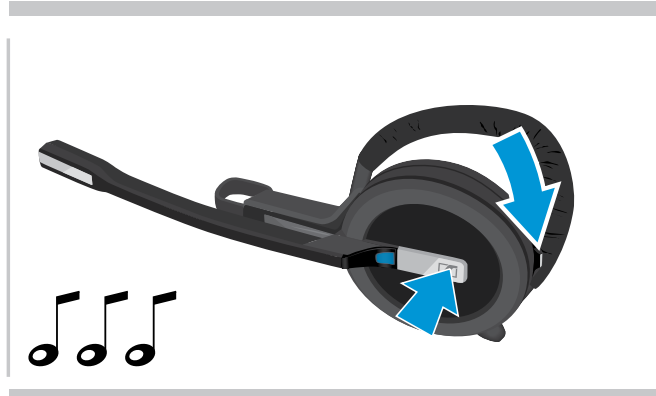

- ▶ Press the volume button down and simultaneously the hook button. Hold the buttons until you hear three beeps. The motion sensor is enabled/disabled and you can choose your wearing side. The voice prompt "*Motion sensor on*" or "*Motion sensor off*" is announced.

Using the motion sensor

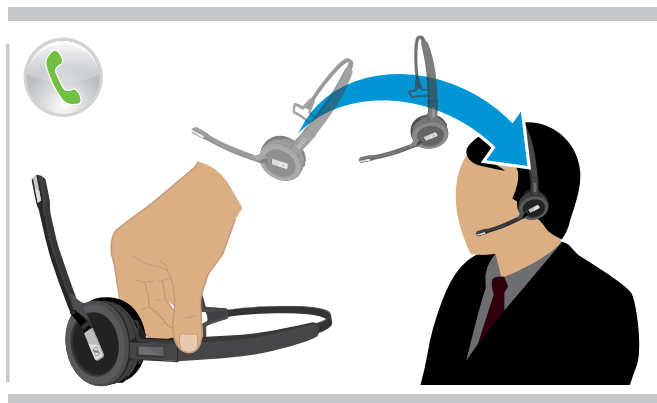

- ▶ Lift the headset from the desk and put it on. The sensor registers motion and the incoming call is accepted.

Charging the headset and storing the headset system

Charging the headset

Always place the headset at the base station to ensure that it is fully charged when needed.

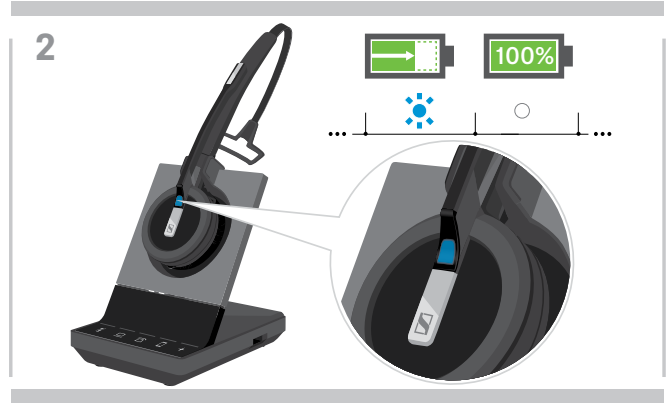

▶ Place the headset into the magnetic holder of the base station.
The headset battery status LEDs on the base station indicate the charge status.

During charging the Headset LED lights up blue. The LED switches off when the headset is fully charged.

LED segment	Required charging time	Corresponds to a talk time of		
		Super Wideband	Wideband	Narrowband
	approx. 10 minutes	approx. 1 hour	approx. 2 hours	approx. 3 hours
	approx. 20 minutes	approx. 2 hours	approx. 4 hours	approx. 6 hours
	approx. 40 minutes	approx. 3 hours	approx. 6 hours	approx. 9 hours
	approx. 60 minutes	approx. 6 hours	approx. 8 hours	approx. 10 hours

Shortly before the rechargeable battery is about to run flat (15 minutes remaining) the voice prompt “*recharge headset*” is announced in the headset.

i If the headset is outside the range of the base station, it will switch off after 30 minutes in order to conserve battery power. To switch it on again, press the headset’s hook button for 5 seconds.

Charging the headset using the CH 30 charger | Charging several headsets simultaneously

The CH 30 headset charger and the MCH 7 multi USB power source are optional accessories. The CH 30 allows you to charge additional SDW headsets, e.g. for sharing the same base station when working in shifts. Several CH 30 in connection with the MCH 7 allow to charge up to 7 headsets simultaneously.

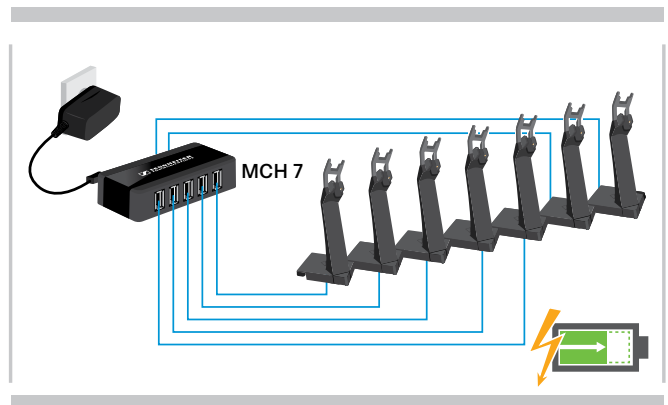
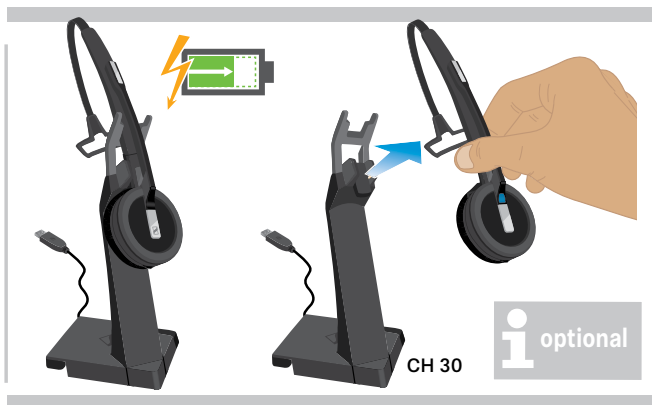

▶ Refer to the Quick Guide of the CH 30 or MCH 7 for more information.

Switching the headset system off during extended non-use

You can switch off the headset system or the headset when not using the products for extended periods of time (e.g. when you are on holiday).

Switching the headset system off



- ▶ Disconnect the base station from the mains power supply and the computer. The base station and headset switch off immediately, all LEDs switch off.

Switching the headset off

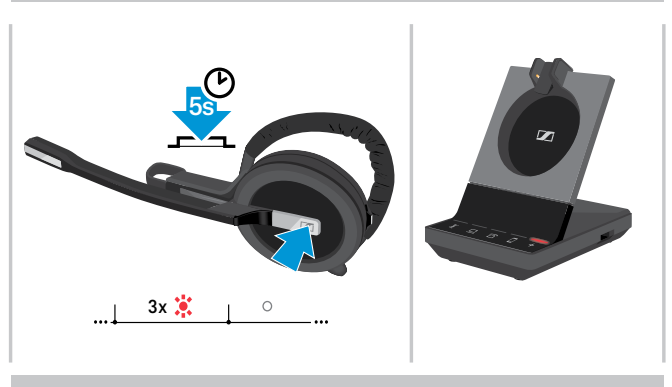

- ▶ Press and hold the hook button for 5 seconds to switch off the headset. The Headset LED flashes red 3 times. The Headset battery status LEDs on the base station switch off. The + LED lights up red.

To switch the headset on again:

- ▶ Press and hold the hook button for 5 seconds.

Sharing a workplace

The SDW 5000 headsets and base stations are compatible with each other. If you share a workplace, you can use one base station with different headsets.

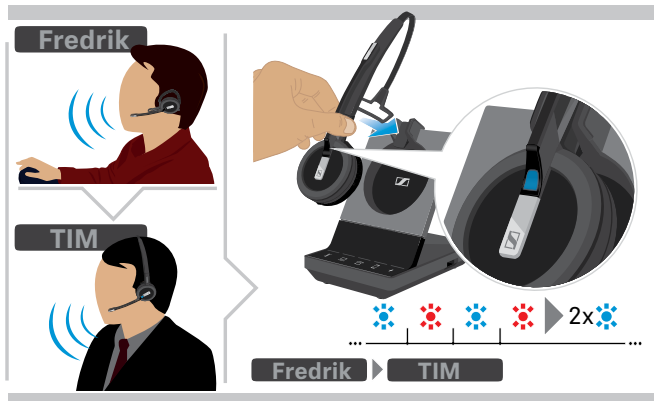

- ▶ Place the headset to be used into the magnetic holder of the base station. The Headset LED alternately flashes blue/red and flashes blue twice if pairing is successful. The headset is ready for use.

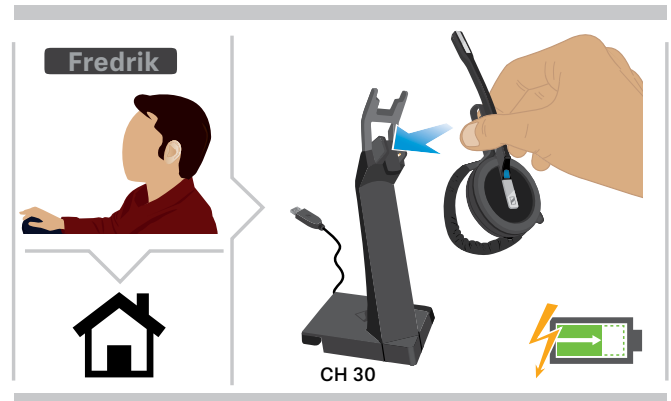

- ▶ Charge the headsets that are not in use with the optional headset charger CH 30 (see page 43).

Using the headset with a third party base station (DECT-GAP telephone)

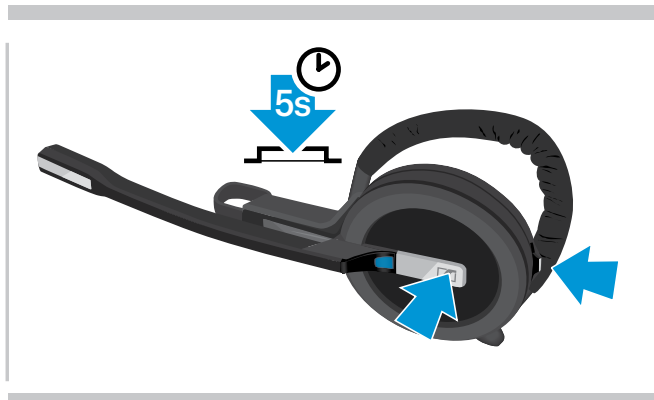

- ▶ Place the headset at a maximum distance of 1 m from the third party base station.
- ▶ Press and hold the headset's hook button and mute button simultaneously for 5 seconds. The headset switches to a special pairing mode and the Headset LED flashes blue/red alternately.
- ▶ Set the third party base station to a special pairing mode (see the instruction manual of the third party base station). The default code for the headset is "0000". The headset pairs with the third party base station. If pairing is successful, the Headset LED switches off.

If pairing is not successful within 60 seconds, the headset switches back to standby mode.

To pair the headset to a SDW 5000 series base station, after having paired it to a GAP enabled device:

- ▶ Place the headset into the magnetic holder of the base station. In this case, the pairing will not be initiated the first time, therefore:
- ▶ Undock the headset and re-dock it again. The headset LED flashes blue/red shortly and turns blue when pairing is complete. The headset will start charging.

Cleaning and maintaining the headset system

CAUTION

Liquids can damage the electronics of the product!

Liquids entering the housing of the device can cause a short circuit and damage the electronics.

- ▷ Keep all liquids far away from the product.
 - ▷ Do not use any cleansing agents or solvents.
-
- ▷ Before cleaning, disconnect the base station from the mains power supply.
 - ▷ Only use a dry and soft cloth to clean the product.

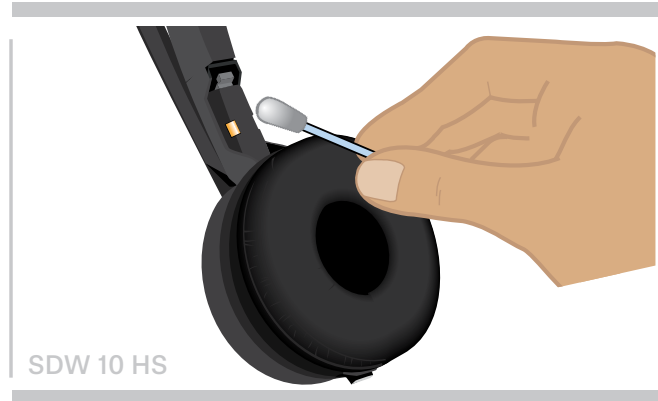

- ▷ Clean the charging contacts of the base station and the headset from time to time using e.g. a cotton swab.

Replacing the ear pads

For hygienic reasons, you should replace the ear pads from time to time. Spare ear pads are available from your Sennheiser partner.

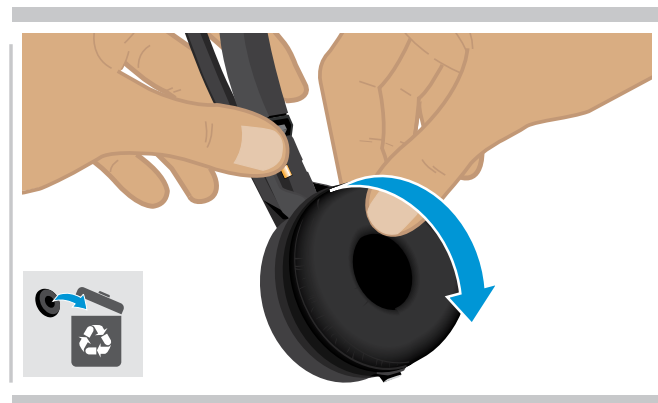

- ▷ Carefully remove the old ear pad from the ear cup.

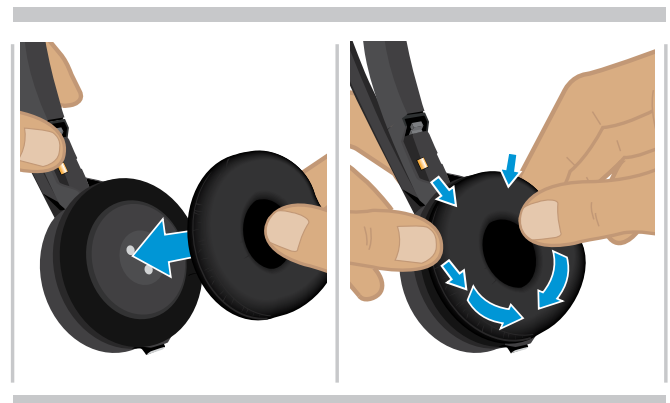

- ▷ Attach the new ear pad to the ear cup by pressing firmly around the ear pad.

Replacing/removing the headset's rechargeable battery

CAUTION

Danger of damage to the product!

During the warranty period, the rechargeable battery must only be replaced by an authorized Sennheiser service center, otherwise the warranty will be null and void.

- ▷ Contact your Sennheiser service center if the rechargeable battery needs to be replaced. To find a Sennheiser service partner in your country, visit www.sennheiser.com.

Outside the warranty period, the rechargeable battery may be replaced or removed by any qualified service center or qualified technician of your IT or Service department. Instructions for qualified technicians on how to replace or remove the battery are available from the Sennheiser service partner.

Updating the firmware of the products

You can update the firmware of your headset system and Bluetooth dongle by using the free [HeadSetup™ Pro](#) software.

- ▷ Connect the base station to your computer and install the required software (see page 11).

Updating the firmware of the base station and the headset

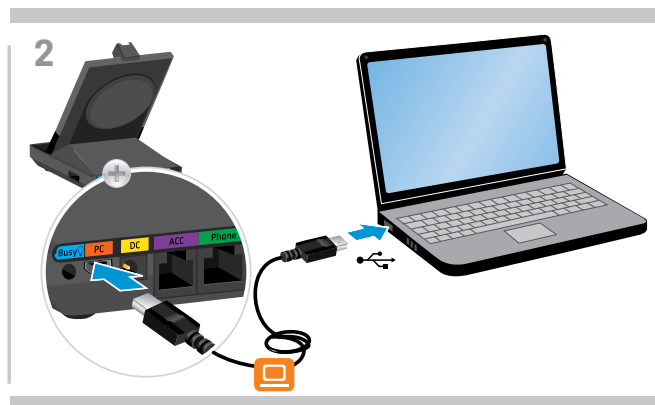

- ▷ Place the headset into the magnetic holder of the base station.
- ▷ Connect the base station via the USB cable with a USB port of your computer.
- ▷ Start [HeadSetup™ Pro](#). [HeadSetup™ Pro](#) checks if the installed firmware is the latest version available on the Sennheiser server. If required, upgrade to the latest version. The headset is automatically updated via the base station.



Updating the firmware of the Bluetooth dongle BTD 800 USB

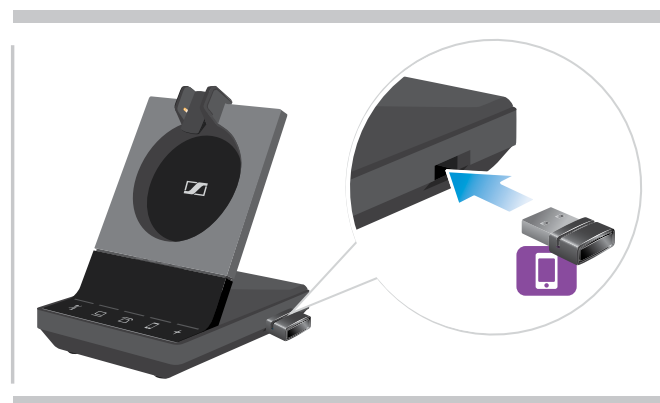

- ▷ Insert the BTD 800 USB into the USB port on the base station. Some older dongle versions need to be connected directly to the computer in order to be updated. “New” dongles can be identified by the two grey lines on the bottom side of the housing.
- ▷ Start [HeadSetup™ Pro](#). [HeadSetup™ Pro](#) checks if the installed firmware is the latest version available on the Sennheiser server. If required, upgrade to the latest version.

If a problem occurs ...

Problem	Possible cause	Solution	Page
The headset is placed into the base station but the charge status LED is off	Base station is not connected to the mains power supply	Connect the base station to the mains power supply.	8
	Rechargeable battery is deeply discharged	Wait several minutes until the Charge status LED lights up.	43
Link between headset and base station cannot be established	Headset is not paired with the base station, the + LED lights up red	Place the headset into the base station.	43
Bad connection between headset and base station	Transmission range is exceeded	Reduce the distance between headset and base station.	30
		Adjust the radio range.	24
Noise interference and connection loss	Microphone rubs on the cheek or perhaps the beard	Adjust the headset so that the microphone is about 0.8 - 1.2" (2 - 3 cm) from the corner of your mouth.	16
	Too many DECT systems within the radio range	Reduce the radio range.	24
	Distance between base station and fixed line phone is so small that interference occurs	Increase the distance between base station and fixed line phone.	-
Headset battery cannot be charged	Charging contacts of the headset or the base station are dirty	Clean the charging contacts on the headset and on the base station.	46
	Rechargeable battery is defective/worn out	Ask a technician to replace the rechargeable battery.	47
	Headset is not properly placed in the base station	Check if the headset is properly placed into the magnetic holder.	43
The sound from the fixed line phone is distorted and disturbed	Base station is not adjusted to the fixed line phone.	Use the ABC switch to adjust the base station to your fixed line phone.	27
Beeps instead of voice prompts	The voice prompts are deactivated	Activate the voice prompts.	29
The talk time is reduced	Worn-out rechargeable battery	Ask a technician to replace the rechargeable battery.	47
	Large distance between base station and headset	Reduce the distance if possible. Larger distances require a higher transmission power and reduce the talk time.	-
	Fast Link activated	Deactivate Fast Link to save battery power.	24
	Many DECT systems in the same area	Switch off DECT systems that are currently not required. Congestion requires a higher transmission power and reduces the talk time. How many DECT systems can be used in the same room? This depends on various conditions: <ul style="list-style-type: none"> Americas: up to 40 SDW systems in narrowband mode or in high density wideband mode (available in HeadSetup™ Pro) Rest of World: up to 80 SDW systems in narrowband mode or in high density wideband mode (available in HeadSetup™ Pro) 	-
	Narrowband/wideband setting	Set the base station to narrowband transmission as it requires less power than wideband transmission.	25

Problem	Possible cause	Solution	Page
Dropped calls due to high density	High density: Too many DECT systems in the same area	Reduce the radio range on all DECT systems in the area.	24
		Reduce audio quality to narrowband or wideband.	25
		Ensure "Fast Link" is not selected on DIP switch 4.	24
Bad audio quality: you sound too low/ distorted/ echoing to the other party/ background noise	Microphone sensitivity is not correctly adjusted	Adjust the microphone sensitivity.	27
	Microphone is too far away from your mouth	Adjust the microphone position.	16
DIP switch settings do not work	Base station settings were updated and overwritten via HeadSetup™ Pro	Reset the system	49
	No system re-boot after DIP switches were changed	Disconnect the base station shortly from power.	23
Headset/ base station does not react to any button press	The operation of the headset or base station is faulty	Reset the products to the factory default settings.	49
No Bluetooth connection via dongle BTD 800 USB	Dongle not inserted correctly in the base station	Plug in the dongle again.	12
	Dongle and mobile device not connected	Pair the dongle and your mobile device (Pairing).	13
		Activate Bluetooth on your mobile device.	–
Dongle and Bluetooth headset not connected	Pair the dongle and your headset (Pairing).	14	
Dongle BTD 800 USB does not accept new devices (Pairing)	Dongle's pairing list disturbed	Clear the list of previously paired devices.	14
Guest headset is not accepted	Guest headset not accepted on Master headset	Repeat the procedure and accept the guest headset on the master.	39
	Guest headset accepted too late on Master headset		
	Too many Guest headsets in use	Leave the conference with one of the other headsets by pressing the hook button on this headset.	

If a problem occurs that is not listed in the above table or if the problem cannot be solved with the proposed solutions, please contact your local Sennheiser partner for assistance. To find a Sennheiser partner in your country, search at www.sennheiser.com.

Restoring factory default settings (Reset)

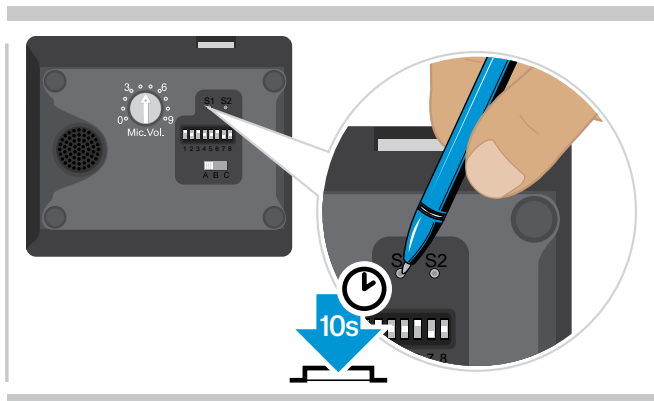

- ▷ Make sure that the base station is powered via USB cable or power supply unit.
- ▷ Use a pointed object to press the Set button S1 for approx. 10 seconds. The base station factory default settings are restored.

Specifications

Base station

Dimensions (W x H x D)

Weight

Connectors

DECT frequency range

RF output power

SDW BS 3

SDW BS 5

87 x 122 x 105 mm / 3.43 x 4.80 x 4.13 in

320 g / 11.29 oz / 0.71 lbs

- | | |
|--|--|
| <ul style="list-style-type: none"> • Power supply socket DC • Micro-USB socket PC • USB socket • Busy light socket Busy | <ul style="list-style-type: none"> • Power supply socket DC • Micro-USB socket PC • USB socket • Busy light socket Busy • Accessory socket ACC • Fixed line phone socket Phone • Handset socket Handset |
|--|--|

European Union:	1880 – 1900 MHz
United States:	1920 – 1930 MHz
Japan:	1893 – 1906 MHz

European Union/Japan:	max. 250 mW (EIRP)
United States:	max. 100 mW (EIRP)

Headset SDW 10 HS

Dimensions (W x H x D)

Weight with...

Talk time

Standby time

Charging time

Range (environment dependent)

Frequency response speaker

Rechargeable battery (built-in)

Output power

Speaker type

Microphone type

50 x 25 x 140 mm / 1.97 x 0.98 x 5.51 in

ear hook: 44 g / 1.55 oz / 0.097 lbs

headband: 58 g / 2.05 oz / 0.13 lbs

neckband: 43 g / 1.52 oz / 0.095 lbs

narrowband: up to 10 hours

wideband: up to 8 hours

super wideband: up to 6 hours

48 hours

50%: approx. 30 minutes

100%: approx. 1 hour

free line of sight: up to 180 m / 590 ft

in office buildings: up to 55 m / 180 ft

150 Hz – 16 kHz (depends on settings)

Lithium Polymer; 3.7 V; 335 mAh

European Union/Japan: max. 250 mW (EIRP)

United States: max. 100 mW (EIRP)

neodymium magnet

electret microphone, noise canceling

Power supply unit

Nominal input voltage

Nominal input current

Mains frequency

Nominal output voltage

Nominal output current

Weight

100 – 240 V~

max. 0.3 A

50 – 60 Hz

5.0 V $\overline{\text{---}}$

2 A

approx. 100 g / 3.53 oz / 0.22 lbs

Bluetooth dongle BTD 800 USB

Dimensions (W x H x D)	22 x 16 x 6 mm / 0.87 x 0.63 x 0.24 in
Weight	2 g / 0.07 oz / 0.004 lbs
Bluetooth	version 4.2/ power class 1
Range	up to 25 m (device-dependent)
Transmission frequency	2402 – 2480 MHz
Profiles	<ul style="list-style-type: none"> • HSP Headset Profile (version 1.2) • HFP Handsfree Profile (version 1.7) • A2DP Advanced Audio Distribution Profile (version 1.3) • AVRCP Audio Video Remote Control Profile (version 1.6)
Output power	max. 8 dBm (EIRP)
Typical sensitivity	-89 dBm

Base station | Headset | BTD 800 USB | Power supply unit

Temperature range	operation:	+5 °C to +45 °C / +41 °F to +113 °F
	storage:	-20 °C to +70 °C / -4 °F to +158 °F
Relative humidity	operation:	20% to 85%
	storage:	20% to 95%

Trademarks

The Bluetooth® word mark and logos are registered trademarks owned by Bluetooth SIG, Inc. and any use of such marks by Sennheiser Communications A/S is under license.

