

DrayTek

Vigor2765 Series

35b Security Router



QUICK START GUIDE (RF MODEL)

V1.1

Vigor2765

35b VDSL2 Router

Quick Start Guide

(Wireless models)

Guide Version: 1.1

Region: United Kingdom & Ireland

For updates and support, visit www.draytek.co.uk

March 2020 / Firmware V4.0.5 BT

Note: Product specification is subject to continuous evolution which may not always be reflected in current documentation. For the formal specification and details of the supported features of your product, please refer only to the web site at www.draytek.co.uk

Safety and Warranty Information

Safety Instructions

- Read the installation guide thoroughly before you set up the router.
- The router is a complicated electronic unit that may be repaired only by authorized and qualified personnel. Do not try to open or repair the router yourself.
- Do not place the router in a damp or humid place, e.g. a bathroom.
- Do not stack the routers.
- The router should be used in a sheltered area, within a temperature range of 0 to +40 Celsius.
- Do not expose the router to direct sunlight or other heat sources. The housing and electronic components may be damaged by direct sunlight or heat sources.
- Do not deploy the cable for LAN connection outdoor to prevent electronic shock hazards.
- Keep the package out of reach of children.
- When you want to dispose of the router, please follow local regulations on conservation of the environment.

Warranty

We warrant to the original end user (purchaser) that the router will be free from any defects in workmanship or materials for a period of two (2) years from the date of purchase from a DrayTek authorized dealer in the UK/Ireland. Please keep your purchase receipt in a safe place as it serves as proof of date of purchase. During the warranty period, and upon proof of purchase, should the product have indications of failure due to faulty workmanship and/or materials, we will, at our discretion, repair or replace the defective products or components, without charge for either parts or labour, to whatever extent we deem necessary to restore the product to proper operating condition. Any replacement will consist of a new or re-manufactured functionally equivalent product of equal value, and will be offered solely at our discretion. This warranty will not apply if the product is modified, misused, tampered with, damaged by external factors, used with unapproved accessories or subjected to abnormal working conditions. Warranty applies to hardware only, not software or firmware. Defects which do not significantly affect the usability of the product will not be covered by the warranty. We reserve the right to revise the manual and online documentation and to make changes from time to time in the contents hereof without obligation to notify any person of such revision or changes.



Declaration of Conformity

Hereby, DrayTek Corporation declares that the radio equipment type Vigor2765/Vigor2766 is in compliance with Directive 2014/53/EU.

The full text of the EU declaration of conformity is available at the following internet address:

<http://www.draytek.com.tw/ftp/Vigor2765/Document/CE/>

Manufacturer: DrayTek Corp.

Address: No. 26, Fu Shing Road, HuKou Township, HsinChu Industrial Park, Hsin-Chu County, Taiwan 303

Product: Vigor2765 Wireless Series

Importer: SEG, 11 Capital Business Park, Borehamwood, Herts, WD6 1GW

Frequency Information for Europe area:

2.4G WLAN	2412MHz - 2472 MHz, max. TX power: 19.98dBm *1
5G WLAN	5160MHz - 5340 MHz, max. TX power: 22 dBm *2 5480MHz - 5720 MHz, max. TX power: 27 dBm
	Requirements in AT/BE/BG/CZ/DZ/DK/EE/FR/DE/IS/IE/IT/EL/ES/ CY/LV/LI/LT/LU/HU/MT/NL/NO/PL/PT/RO/SI/SK/TR/FI/SE/CH/ UK/HR. 5150MHz~5350MHz is for indoor use only.

(*1: for 2.4G WLAN model; *2: for 5G WLAN model)

This product is designed for PSTN, DSL and 2.4GHz / 5GHz WLAN network use in the UK & Ireland.



Join the UK mailing list

Users in the UK & Ireland can sign up to our mailing list which goes out approximately 4 times per year with products news, updates, hints & tips and offers. For details, please visit www.draytek.co.uk/list

Firmware & Tools Updates

Due to the continuous evolution of DrayTek technology and emerging risks, router firmware updates may be issued. Please consult the DrayTek web site for more information on newest firmware, tools and documents: www.draytek.co.uk (For UK/Ireland)

Regional and Network Compatibility

For all models, please check that you have been supplied with a device intended for your geographic region and networks. Hardware and software varies by region, as well as local support and warranty services. To be sure of compatibility and local support, ensure that you are buying the correct product through authorized channels. The outside of the product's box will state the region compatibility (e.g. "Applied Region: UK"). If you are unsure, check with DrayTek or your supplier. The use of unofficial components (e.g. PSUs) or adapting interfaces or the use of unauthorized software/firmware may cause malfunction, product damage or personal danger and invalidates your warranty and access to support services.

External Power Supply (Power Adapter) Information

	1	2	3	4	5	6	7	8	9
A Manufacturer	CWT	CWT	CWT	CWT	CWT	APD	APD	APD	APD
B Address	No. 222, Sec. 2, Nankan Rd., Lujhu Township, Taoyuan County 338, Taiwan	No. 222, Sec. 2, Nankan Rd., Lujhu Township, Taoyuan County 338, Taiwan	No. 222, Sec. 2, Nankan Rd., Lujhu Township, Taoyuan County 338, Taiwan	No. 222, Sec. 2, Nankan Rd., Lujhu Township, Taoyuan County 338, Taiwan	No. 222, Sec. 2, Nankan Rd., Lujhu Township, Taoyuan County 338, Taiwan	No.5, Lane 83, Lung-Sou St., Taoyuan City 330, Taiwan	No.5, Lane 83, Lung-Sou St., Taoyuan City 330, Taiwan	No.5, Lane 83, Lung-Sou St., Taoyuan City 330, Taiwan	No.5, Lane 83, Lung-Sou St., Taoyuan City 330, Taiwan
C Model identifier	ZABBO12F UK ZABBO12F EU	ZABBO18F UK ZABBO18F EU	ZABLO24F UK ZABLO24F EU	ZABLO30F UK ZABLO30F EU	ZABNO36F UK ZABNO36F EU	WA-12M12FG WA-12M12FK	WB-18D12FG WB-18D12FK	WA-24Q12FG WA-24Q12FK	WA-36A12FG WA-36A12FK
D Input voltage	100-240V	100-240V	100-240V	100-240V	100-240V	100-240V	100-240V	100-240V	100-240V
E Input AC frequency	50/60Hz	50/60Hz	50/60Hz	50/60Hz	50/60Hz	50/60Hz	50/60Hz	50/60Hz	50/60Hz
Output voltage DC	12.0V	12.0V	12.0V	12.0V	12.0V	12.0V	12.0V	12.0V	12.0V
F Output current	1.0A	1.5A	2.0A	2.5A	3.0A	1.0A	1.5A	2.0A	3.0A
G Output power	12.0W	18.0W	24.0W	30.0W	36.0W	12.0W	18.0W	24.0W	36.0W
H Average active efficiency	84.9%	86.2%	87.6%	87.8%	89.8%	83.7%	85.4%	88.6%	88.2%
I Efficiency at low load 10%	73.6%	78.0%	81.3%	83.3%	83.7%	74.5%	80.5%	86.4%	85.4%
J No-load power consumption	0.07W	0.07W	0.07W	0.07W	0.07W	0.07W	0.10W	0.07W	0.10W

For more updates & information, please visit www.draytek.co.uk. The external power supply used for each product will be model dependent.

Table of Contents

1. Introduction.....	1
2. Package Contents	2
3. Panel Explanation.....	3
3.1 Vigor2765ac	3
3.2 Vigor2765Vac	5
4. Hardware Installation	7
4.1 Connecting up the Vigor 2765.....	7
4.2 Wall-Mounting the Vigor 2765	8
5. Setup & Configuration.....	9
5.1 Accessing the Router Web Interface.....	9
5.2 WAN1 – ADSL & VDSL Connection Setup	12
5.2.1 PPPoE connection with FTTC VDSL2	12
5.2.2 DHCP / Static IP connection with FTTC VDSL2	15
5.2.3 PPPoA connection with ADSL / ADSL2+.....	18
5.3 WAN2 – Ethernet Connection Setup.....	20
5.3.1 Enabling the Ethernet WAN Port	20
5.3.2 PPPoE.....	22
5.3.3 Static or Dynamic IP.....	23
5.4 WAN3 / WAN4 – 3G / 4G USB Modem Setup	24
5.4.1 PPP Mode	24
5.4.2 DHCP Mode	26
6. Getting Further Help.....	27
6.1 Additional Feature Setup.....	27
6.2 Keep up to date with our mailing list	27
6.3 Firmware Updates.....	28
6.4 Security & Router Best Practice.....	28

1. Introduction

The Vigor2765 series is a VDSL2 35b router / firewall with guest network capability for fast and secure home and small office connectivity, designed for bandwidth-intensive applications such as high-definition video streaming, online gaming and Internet telephony.

Packed with advanced features, the Vigor 2765 series offers truly comprehensive DSL connectivity and security. Compatible with all UK variants of ADSL (including ADSL2+ and Annex M), VDSL2 (BT Infinity™/FTTC/35b), the Vigor 2765 can also be used for cable-modem or fibre connections, using LAN port P4 in Ethernet WAN mode and 3G/4G cellular service with supported USB modems.

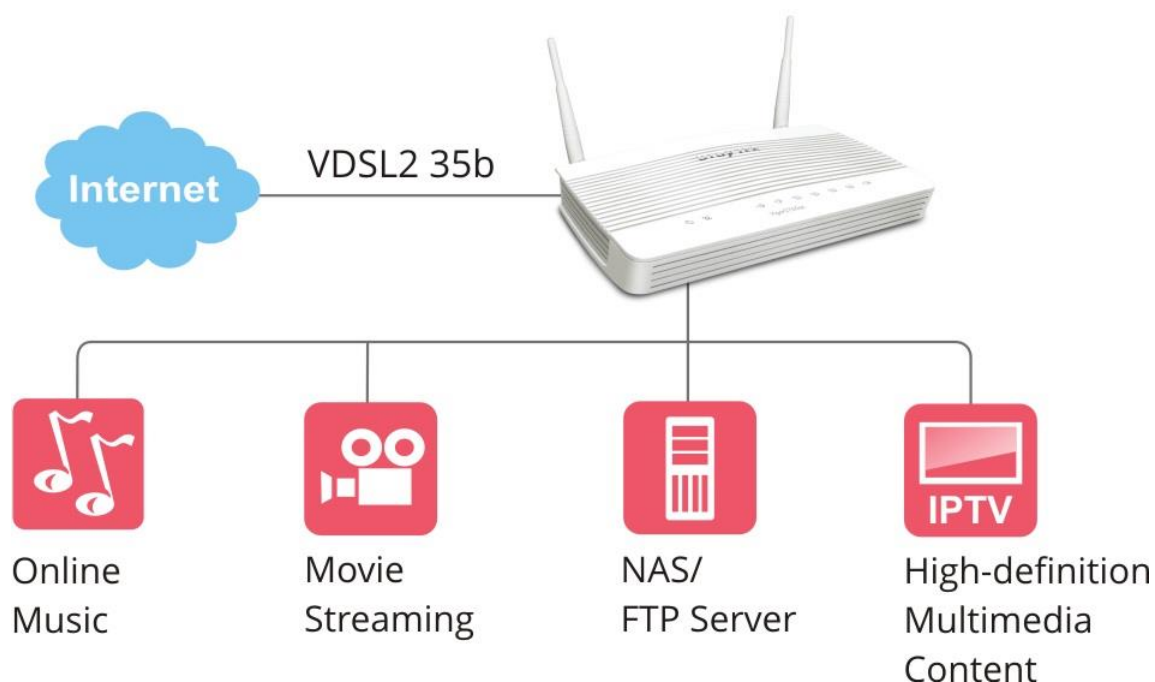

GlobalView Web Content Filtering allows blocking of websites based on the category they're determined to fit in, which is managed by the GlobalView servers, making it far simpler to block unwanted sites (e.g. Gambling and adult categories) with less maintenance required as new or changed site categorisations are continuously updated. A free 30-day trial is included with your new router.

The router's hardware accelerated IPSec/SSL/L2TP VPN (Virtual Private Networking) functionality can dial-out quickly and securely to an office VPN server for teleworking.

The SSL VPN server allows you to connect your computer, phone or tablet into your home network from anywhere, with access to network storage and secure Internet connectivity through the SSL VPN tunnel.

2. Package Contents



DrayTek Vigor 2765 router



Quick Start Guide
(This document)

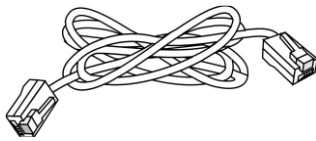

RJ-45 Cable (Ethernet)
(Connects to your PC or Switch)

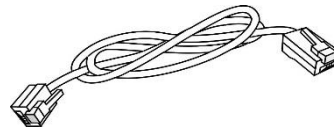

RJ-11 to RJ-11 Cable
(Connects to your DSL line)

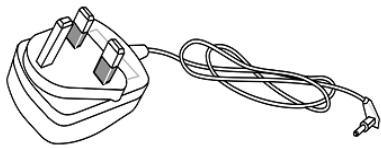

UK Power Adapter

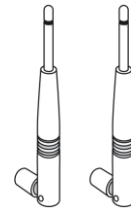

Antenna

The maximum power consumption is **17-23 Watts**.









**Important
Note**

Remove the protective film from the router before use to ensure ventilation.

3. Panel Explanation

3.1 Vigor2765ac





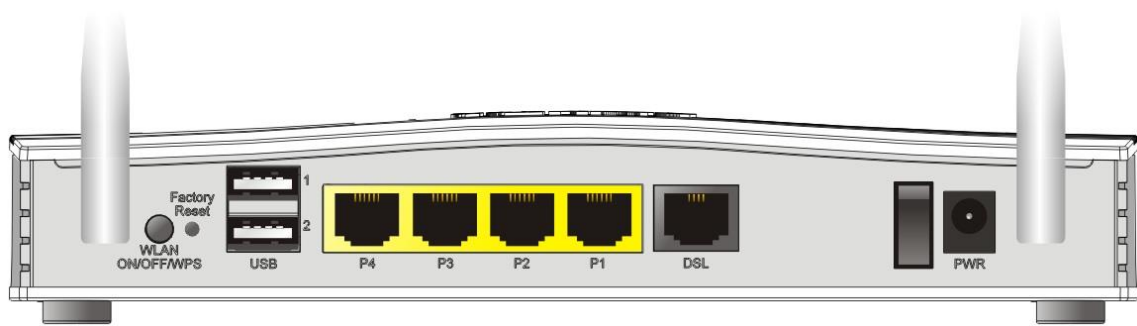





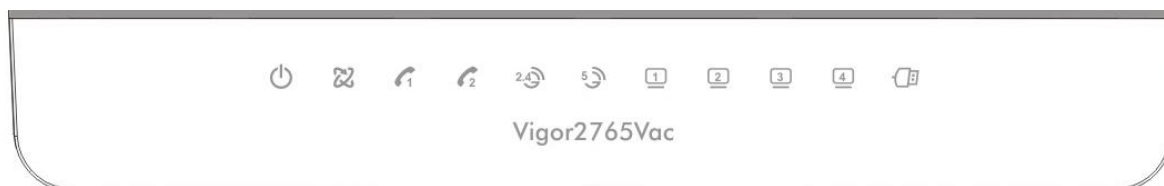

LED	Status	Explanation	
 (Activity)	Blinking	The router is ready and operating normally	
	Off	The router is powered off	
 (DSL)	Orange	On	DSL connection synchronised, waiting for Internet connection to establish
		Blinking	Slowly - DSL link not detected Quickly - DSL connection synchronising
	Green	On	Internet connection established, ready for use
		Blinking	Data is being transmitted over WAN
 (Wireless LAN On/Off/WPS)	On (Green)		2.4GHz Access Point is active
	Blinking (Green)		Data is being transmitted on the router's 2.4 GHz wireless interface
	Blinking (Orange)		WPS pairing mode is active for two minutes
	Off		2.4GHz Access Point is turned off
 (Wireless LAN On/Off/WPS)	On (Green)		5GHz Access Point is active
	Blinking (Green)		Data is being transmitted on the router's 5GHz wireless interface
	Blinking (Orange)		WPS pairing mode is active for two minutes
 (LAN1/2/3/4)	On		Ethernet LAN (RJ45) is connected
	Blinking		Data is transmitting (sending/receiving)
	Off		Ethernet LAN is disconnected
 (USB)	On		USB device is connected and ready for use
	Blinking		Data is being transmitted over USB



Interface	Description
WLAN ON/OFF/WPS	<p>Press for less than 2 seconds to switch toggle the router's wireless interfaces:</p> <p>For example,</p> <ul style="list-style-type: none"> ● 2.4G (On) and 5G (On) - Default state. ● 2.4G (Off) and 5G (On) - press and release the button once. ● 2.4G (On) and 5G (Off) - press and release the button twice. ● 2.4G (Off) and 5G (Off) - press and release the button three times. <p>When WPS is enabled in the router's web interface, press this button for more than 2 seconds to enable WPS pairing mode.</p>
Factory Reset	<p>Restore the default settings.</p> <p>Usage: Turn on the router (ACT LED is blinking). Press gently and hold for more than 5 seconds. When the ACT LED blinks rapidly, release the button. Then the router will restart with the factory default configuration</p>
USB1~USB2	Connector for a USB 3G/4G modem, storage, printer or USB Thermometer
P1~P4	<p>RJ-45 Gigabit Ethernet connectors for local network devices.</p> <p>LAN port P4 can be configured as the Ethernet WAN port, see Section 5.3 for details</p>
DSL	RJ-11 connector for ADSL or VDSL line
I/O	Power Switch. Turns the unit on (I) or off (O)
PWR	Connector for the power adapter

3.2 Vigor2765Vac



LED	Status	Explanation	
 (Activity)	Blinking	The router is ready and operating normally	
	Off	The router is powered off	
 (DSL)	Orange	On	DSL connection synchronised, waiting for Internet connection to establish
		Blinking	Slowly - DSL link not detected Quickly - DSL connection synchronising
	Green	On	Internet connection established, ready for use
		Blinking	Data is being transmitted over WAN
 	On	The phone connected to this port is off-hook	
	Off	The phone connected to this port is on-hook	
	Blinking	A phone call is incoming	
 (Wireless LAN On/Off/WPS)	On (Green)	2.4GHz Access Point is active	
	Blinking (Green)	Data is being transmitted on the router's 2.4 GHz wireless interface	
	Blinking (Orange)	WPS pairing mode is active for two minutes	
	Off	2.4GHz Access Point is turned off	
 (Wireless LAN On/Off/WPS)	On (Green)	5GHz Access Point is active	
	Blinking (Green)	Data is being transmitted on the router's 5GHz wireless interface	
	Blinking (Orange)	WPS pairing mode is active for two minutes	
	Off	5GHz Access Point is turned off	
  ~ (LAN1/2/3/4)	On	Ethernet LAN (RJ45) is connected	
	Blinking	Data is transmitting (sending/receiving)	
	Off	Ethernet LAN is disconnected	
 (USB)	On	USB device is connected and ready for use	
	Blinking	Data is being transmitted over USB	

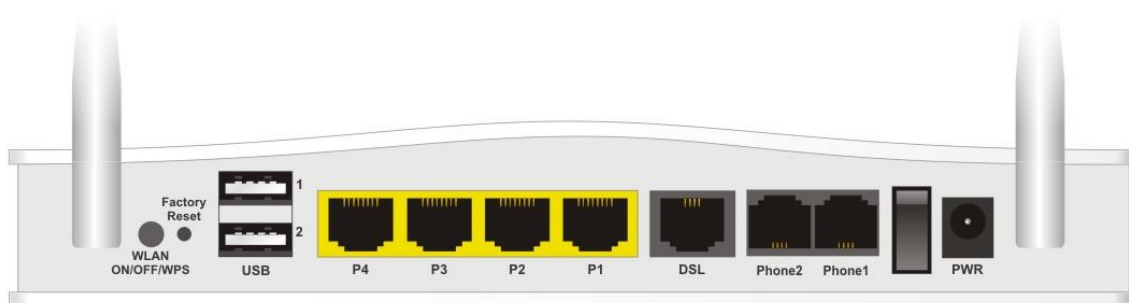

Interface	Description
WLAN ON/OFF/WPS	<p>Press for less than 2 seconds to switch toggle the router's wireless interfaces:</p> <p>For example,</p> <ul style="list-style-type: none"> ● 2.4G (On) and 5G (On) - Default state. ● 2.4G (Off) and 5G (On) - press and release the button once. ● 2.4G (On) and 5G (Off) - press and release the button twice. ● 2.4G (Off) and 5G (Off) - press and release the button three times. <p>When WPS is enabled in the router's web interface, press this button for more than 2 seconds to enable WPS pairing mode.</p>
Factory Reset	<p>Restore the default settings.</p> <p>Usage: Turn on the router (ACT LED is blinking). Press gently and hold for more than 5 seconds. When the ACT LED blinks rapidly, release the button. Then the router will restart with the factory default configuration</p>
USB1~USB2	Connector for a USB 3G/4G modem, storage, printer or USB Thermometer
P1~P4	<p>RJ-45 Gigabit Ethernet connectors for local network devices.</p> <p>LAN port P4 can be configured as the Ethernet WAN port, see Section 5.3 for details</p>
DSL	RJ-11 connector for ADSL or VDSL line
Phone2/Phone1	RJ-11 connectors for VoIP usage with analogue telephones
I/O	Power Switch. Turns the unit on (I) or off (O)
PWR	Connector for the power adapter

4. Hardware Installation

4.1 Connecting up the Vigor 2765

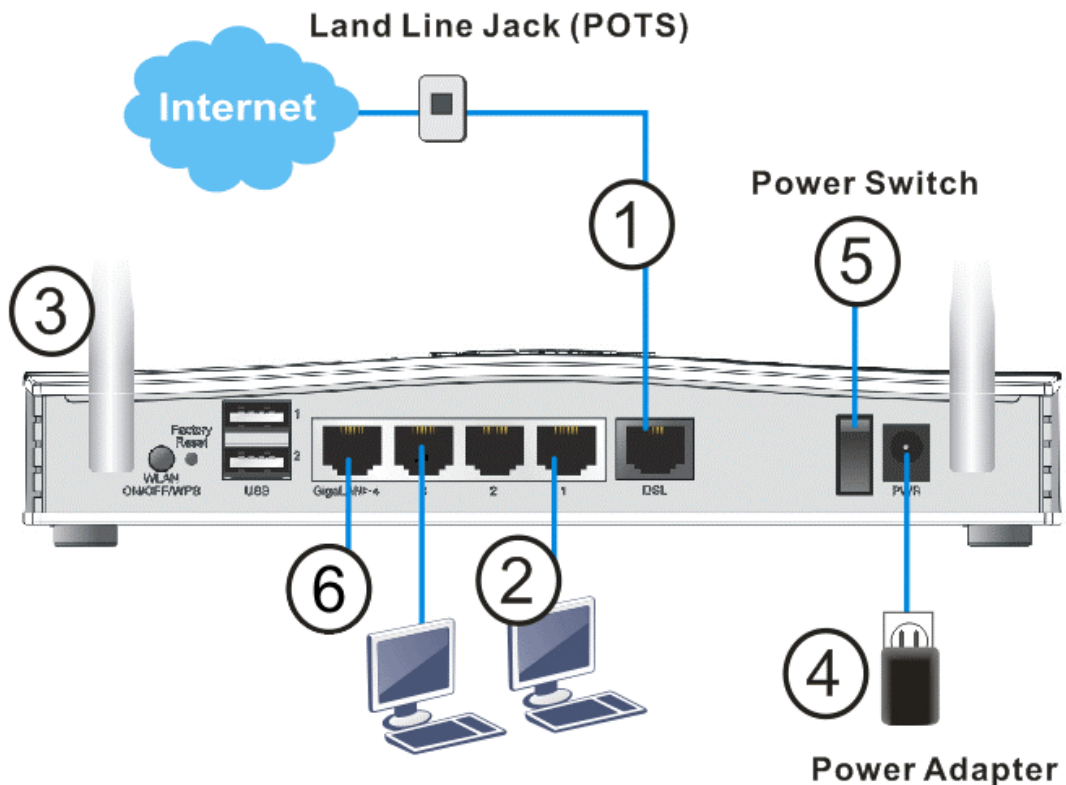

1. **ADSL/VDSL Connections:** Connect the **DSL** port to the **Modem** or **DSL** port of the external splitter/microfilter (not supplied) with the RJ-11 line cable. In some cases, your RJ-11 DSL socket will be built-into your phone line socket on the wall and you won't have a separate microfilter/splitter.
2. **LAN Connections:** Connect a LAN port of the router to your computer or switch.
3. **Wireless Antennas:** Connect the wireless antennas to the router
4. **Power Supply:** Connect the power adapter to the Vigor 2765's **PWR** socket on the rear and plug the power adapter into a suitable mains socket. Turn the Vigor 2765 on using its power switch.
5. The router will start up. After completing the system test, the **ACT** LED will light up and start blinking once per second to indicate that it is ready for use. For more detailed information of LED status, please refer to section 3.1 Front Panel Overview.
6. **Ethernet-based Internet Connections:** LAN port P4 can be switched to operate as the Ethernet WAN port. This must be configured in the router's web interface before it can operate in this mode - Section 5.3 of this Quick Start Guide details how to do that.

4.2 Wall-Mounting the Vigor 2765

DrayTek Vigor 2765 series routers have keyhole type mounting slots on the underside to hang the router on, using screws attached to a wall or other surface.

1. A template is provided in the Vigor router packaging box to enable you to space the screws correctly on the wall
2. Place the template on the wall in the desired position and drill holes through the cardboard template at the marked points
3. Fit screws into the wall using the appropriate type of wall plug
4. With the screws installed, the router can be slotted into place

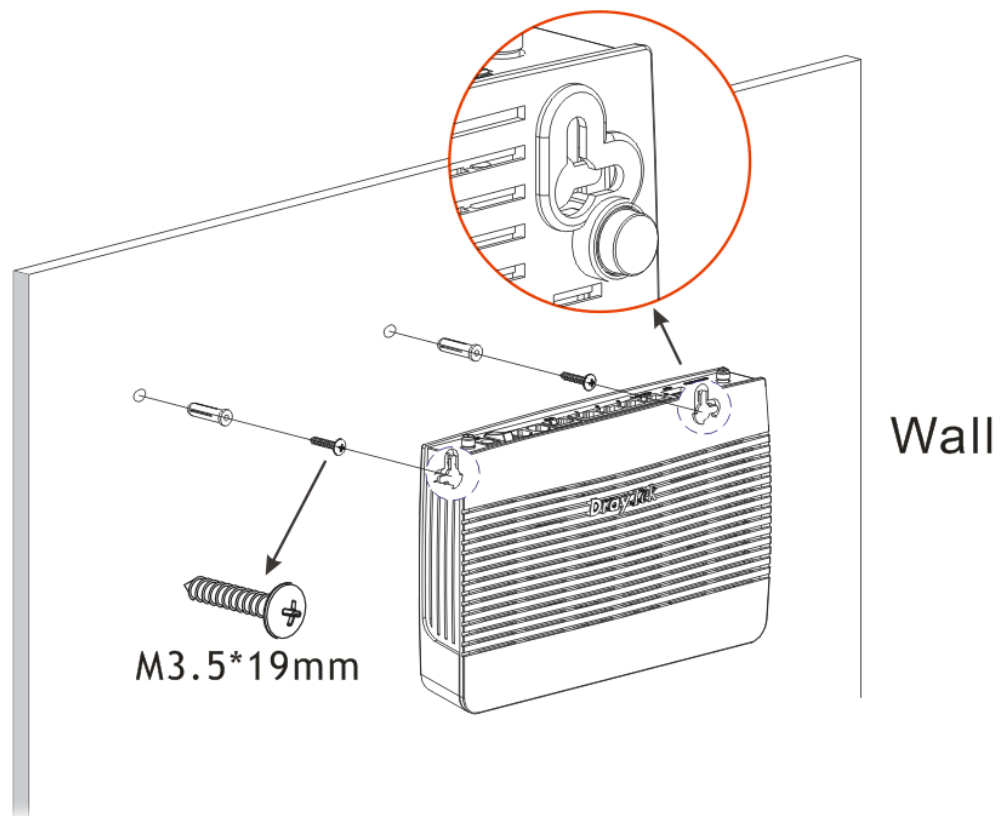

Note

The recommended drill diameter is 6.5mm (1/4").

5. Setup & Configuration

This section provides examples of how to initially access the router and configure internet access for the most common types of Internet connection in the UK.

If the instructions in this quick start guide do not allow you to get online with your ISP or type of Internet connection, there are additional guides available from the Product Knowledgebase on www.draytek.co.uk.



Note

To access the router, your PC will need to either get its IP address using DHCP or have an IP address in the 192.168.1.x range.

For details on how to change this, please refer to the “Trouble Shooting” section in the User Guide.

5.1 Accessing the Router Web Interface

Open a web browser on your PC and type `https://192.168.1.1`.

The `https://` prefix ensures that your connection is encrypted using SSL so that your session data cannot be intercepted. Without that prefix, your data passes in clear text.

You may get a warning from your browser (IE, Chrome, Edge, Safari etc.) about your server (the router) having an invalid certificate. Your browser will demand further confirmation or exception before allowing access. The warnings will look something like these examples.

An example of how to access the router via HTTPS with Mozilla Firefox:

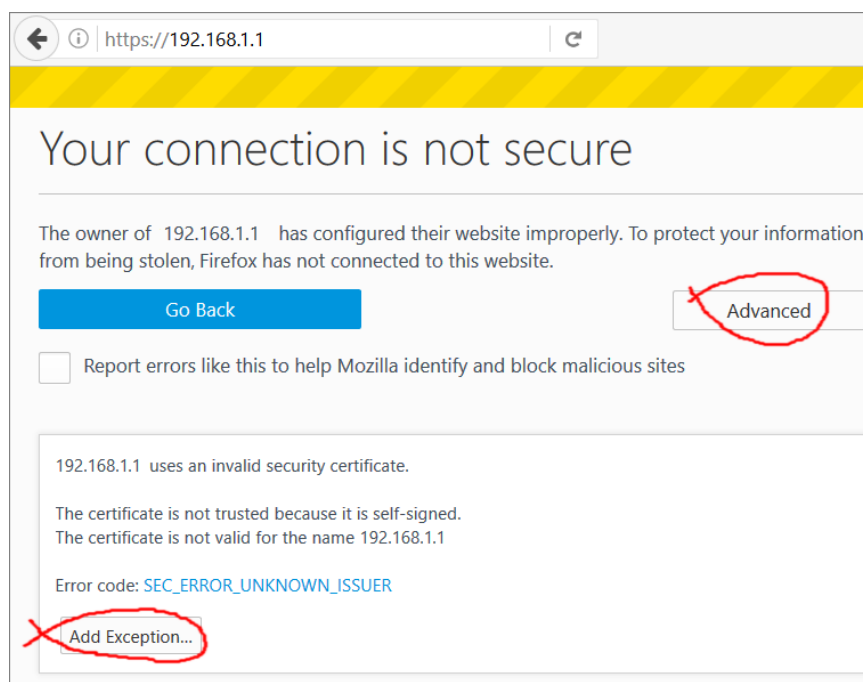

An example from Microsoft Edge, click “Continue to this webpage” to proceed:

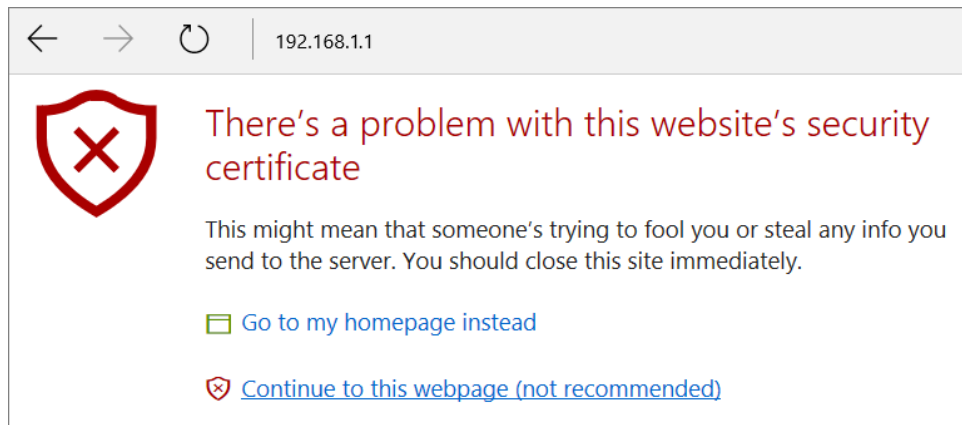

Most other browsers will present equivalent warnings. In each case, following the prompts/links will allow you to access the router's web interface. It is still encrypted with SSL/TLS.



Note

This warning appears because the router's default certificate is 'self-signed' rather than issued to you by a certificate authority who has verified your identity. A self-signed certificate means that you cannot verify the identity of the server, but as it's your own local router, that shouldn't be an issue - your connection is still encrypted.

The router login prompt will then request a username and password to allow access.



The factory default login details are:

Username: admin
Password: admin



Note

If you cannot access the web interface, please go to the “Trouble Shooting” section in the User Guide to determine the cause of and solve your problem.

Upon successful login, the router will display the **Dashboard**, which shows a summary of the router model, WAN status, front panel port status and other information:

System Information

Model Name	Vigor2765ac	System Up Time	0:02:34
Router Name	DrayTek	Current Time	Sat Jan 01 2000 00:02:21
Firmware Version	r87406_beta	Build Date/Time	Dec 20 2019 14:33:40
DSL Version	08-08-00-0F-00-07	LAN MAC Address	00-1D-AA-40-D8-90

IPv4 LAN Information

	IP Address	DHCP		IP Address	DHCP
LAN1	192.168.1.1/24	v	LAN2	192.168.2.1/24	v
IP Routed Subnet	192.168.0.1/24	v			

IPv4 Internet Access

Line / Mode	IP Address	MAC Address	Up Time	
WAN1	VDSL2 / PPPoE	Disconnected	00-1D-AA-40-D8-91	00:00:00
WAN2	Ethernet / ---	Disconnected	00-1D-AA-40-D8-92	00:00:00
WAN3	USB / ---	Disconnected	00-1D-AA-40-D8-93	00:00:00

Interface

DSL	Connected : Down Stream : 0Kbps / Up Stream : 0Kbps
WAN	Connected : 0, WAN1 WAN2 WAN3
LAN	Connected : 0, Port1 Port2 Port3 Port4
WLAN	Connected : 0
WLAN5G	Connected : 0
USB	Connected : 0, USB 1, USB 2

Quick Access

- System Status
- Dynamic DNS
- TR-069
- IMPP2P Block
- Schedule
- SysLog / Mail Alert
- RADIUS
- Firewall Object Setting
- Data Flow Monitor



Note

We recommend configuring a secure password when first logging in to the router’s administration interface.

The router’s administration password can be changed from [System Maintenance] > [Administrator Password]

5.2 WAN1 – ADSL & VDSL Connection Setup

The WAN1 interface of the Vigor 2765 router can connect to VDSL2 / 35b and ADSL2+ lines.

If your Internet connection uses VDSL2 and your ISP has supplied you with a Username and Password to connect to the Internet, go to section

5.2.1 PPPoE connection with FTTC VDSL2

If your Internet connection uses VDSL2 and your ISP does not supply or require a Username and Password to connect to the Internet, go to section

5.2.2 DHCP / Static IP connection with FTTC VDSL2

If your Internet connection uses ADSL or ADSL2+ and your ISP has supplied you with a Username and Password to connect to the Internet, go to section

5.2.3 PPPoA connection with ADSL / ADSL2+

5.2.1 PPPoE connection with FTTC VDSL2

1. Go to [WAN] > [General Setup] and click on the WAN1 link:

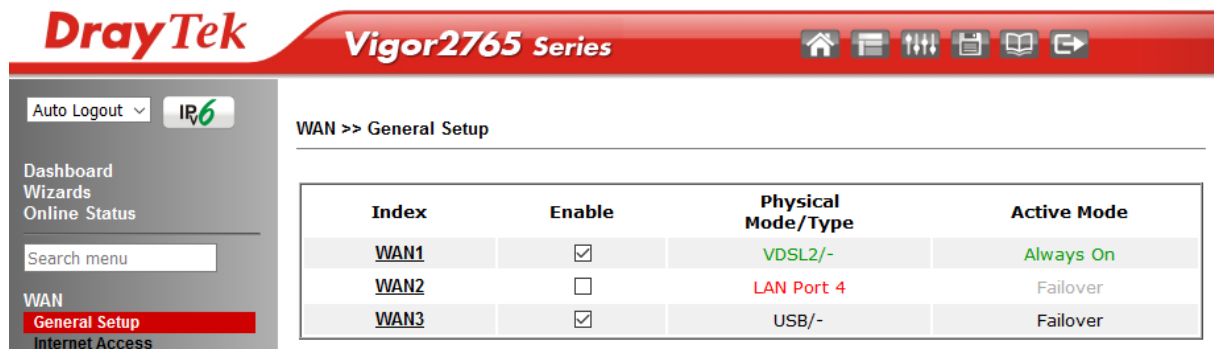

DrayTek Vigor2765 Series

Auto Logout | IPv6

Dashboard
Wizards
Online Status

Search menu

WAN
General Setup
Internet Access

WAN >> General Setup

Index	Enable	Physical Mode/Type	Active Mode
WAN1	<input checked="" type="checkbox"/>	VDSL2/-	Always On
WAN2	<input type="checkbox"/>	LAN Port 4	Failover
WAN3	<input checked="" type="checkbox"/>	USB/-	Failover

2. On the settings page:

- Set the Enable option to Yes to activate the WAN1 connection
- Set the Active Mode to Always On
- **Enable the Service - VLAN Tag insertion**
- Set the **Tag value** setting to **101**
- DSL mode can be set to “VDSL2 only” but this is not required



Note

The VLAN tag value of 101 is required to connect to ISPs that operate on the Openreach VDSL2 network, if your ISP operates on a different VDSL2 network, this tag value may differ. Please check with your ISP or the DrayTek UK Knowledgebase for ISP specific guides.

WAN 1

Enable:	Yes ▾	
Display Name:	<input type="text"/>	
Physical Mode:	VDSL2	
DSL Mode:	Auto ▾	
DSL Modem Code:	AnnexA_779517_773F01 ▾	
Line Speed(Kbps):		
DownLink	<input type="text" value="0"/>	
UpLink	<input type="text" value="0"/>	
Active Mode:	Always On ▾	
VLAN Tag insertion	Customer	Service
ADSL	Disable ▾ Tag value Priority <input type="text" value="0"/> <input type="text" value="0"/> (0~4095) (0~7)	
VDSL2	Disable ▾ Tag value Priority <input type="text" value="0"/> <input type="text" value="0"/> (0~4095) (0~7)	Enable ▾ Tag value Priority <input type="text" value="101"/> <input type="text" value="0"/> (0~4095) (0~7)

Click **OK** on that page to apply the changes.

3. Go to [WAN] > [Internet Access]

Set the **WAN1 Access Mode** to **PPPoE / PPPoA**, then click the **Details Page** button to proceed:

Auto Logout ▾

Dashboard
Wizards
Online Status

WAN

General Setup

Internet Access

Multi-PVC/VLAN

WAN Budget

LAN

WAN >> Internet Access

Internet Access

Index	Physical Mode	1 Access Mode	2
WAN1	ADSL / VDSL2	PPPoE / PPPoA ▾	Details Page
WAN2	Ethernet	None ▾	Details Page
WAN3	USB	None ▾	Details Page

4. On the PPPoE / PPPoA settings tab:

Select the **Enable** radio button at the top of the page to ensure that the PPPoE interface is enabled.

In the **ISP Access Setup** section, input the ISP username into the **Username** field and password in the **Password** field.

If your ISP has provided a static IP address, that can be specified by setting the **Fixed IP** setting to **Yes** and entering the IP in the **Fixed IP Address** field.

WAN 1

PPPoE / PPPoA	MPoA / Static or Dynamic IP	IPv6
<input checked="" type="radio"/> Enable <input type="radio"/> Disable		
ADSL Modem Settings Multi-PVC channel: Channel 1 VPI: 0 VCI: 38 Encapsulating Type: VC MUX Protocol: PPPoA Modulation: Multimode		
ISP Access Setup Username: 23456@HG01.btclick.com Password: ●●●●●●●● More Options		
PPP/MP Setup PPP Authentication: PAP or CHAP IP Assignment (IPCP): <input type="radio"/> Static <input checked="" type="radio"/> Dynamic Fixed IP Address: <input type="text"/> WAN IP Alias: <input type="text"/>		
Dial-Out Schedule Index(1-15) in <u>Schedule</u> Setup: None => None => None => None		
PPPoE Pass-through <input type="checkbox"/> For Wired LAN ² <input type="checkbox"/> For Wireless LAN		

Click **OK** on this page to apply the changes and the router will then prompt to restart. Click the OK button to restart the router.

- Once the router has restarted, the **[Online Status] > [Physical Connection]** page will display the VDSL information and PPP connection status, if the WAN1 section shows an IP address, it has connected to the internet successfully:

Auto Logout

Dashboard
Quick Start Wizard
Online Status
Physical Connection
Virtual WAN

WAN
LAN
NAT
Firewall
User Management
Objects Setting
CSM
Bandwidth Management
Applications
VPN and Remote Access
Certificate Management
Wireless LAN
SSL VPN
USB Application
System Maintenance
Diagnostics
External Devices

Support Area
Product Registration

Online Status

Physical Connection System Uptime: 0:8:44

IPv4		IPv6	
LAN Status	Primary DNS: 194.72.0.98	Secondary DNS: 213.120.234.26	
IP Address	TX Packets	RX Packets	
192.168.1.1	0	0	

WAN 1 Status >> [Drop PPPoA](#)

Enable	Line	Name	Mode	Up Time		
Yes	VDSL2		PPPoE	0:07:41		
IP	GW IP	TX Packets	TX Rate(Bps)	RX Packets	RX Rate(Bps)	
217.34.6.35	217.42.145.215	224580	805	339568	963	

WAN 2 Status

Enable	Line	Name	Mode	Up Time		
Yes	Ethernet		---	00:00:00		
IP	GW IP	TX Packets	TX Rate(Bps)	RX Packets	RX Rate(Bps)	
---	---	0	0	0	0	

WAN 3 Status

Enable	Line	Name	Mode	Up Time	Signal
Yes	USB		---	00:00:00	-
IP	GW IP	TX Packets	TX Rate(Bps)	RX Packets	RX Rate(Bps)
---	---	0	0	0	0

VDSL2 Information (VDSL2 Firmware Version: 8B0F07_A/B/C)

Profile	State	UP Speed	Down Speed	SNR Upstream	SNR Downstream
17A	SHOWTIME	20000 (Kbps)	80000 (Kbps)	15 (0.1dB)	6 (0.1dB)



Note

If the WAN 1 IP address displayed begins with 172.16.x.x, it's possible that the ISP has not accepted the supplied Username and Password for the Internet connection.

Check that the ISP Access Setup - Username and Password match the details supplied by your ISP.

5.2.2 DHCP / Static IP connection with FTTC VDSL2

1. Go to [WAN] > [General Setup] and click on the WAN1 link:

DrayTek Vigor2765 Series

Auto Logout IPv6

Dashboard
Wizards
Online Status

Search menu

WAN
General Setup
Internet Access

WAN >> General Setup

Index	Enable	Physical Mode/Type	Active Mode
WAN1	<input checked="" type="checkbox"/>	VDSL2/-	Always On
WAN2	<input type="checkbox"/>	LAN Port 4	Failover
WAN3	<input checked="" type="checkbox"/>	USB/-	Failover

2. On the settings page:

- Set the Enable option to Yes to activate the WAN1 connection
- Set the Active Mode to Always On
- **Enable the Service - VLAN Tag insertion**
- Set the Tag value setting to 101
- DSL mode can be set to "VDSL2 only" but this is not required



Note

The VLAN tag value of 101 is required to connect to ISPs that operate on the Openreach VDSL2 network, if your ISP operates on a different VDSL2 network, this tag value may differ.

Please check with your ISP or the DrayTek UK Knowledgebase for ISP specific guides.

WAN 1

Enable:	Yes ▾	
Display Name:	<input type="text"/>	
Physical Mode:	VDSL2	
DSL Mode:	Auto ▾	
DSL Modem Code:	AnnexA_779517_773F01 ▾	
Line Speed(Kbps):		
DownLink	<input type="text" value="0"/>	
UpLink	<input type="text" value="0"/>	
Active Mode:	Always On ▾	
VLAN Tag insertion	Customer	Service
ADSL	Disable ▾ Tag value <input type="text" value="0"/> Priority <input type="text" value="0"/> (0~4095) (0~7)	
VDSL2	Disable ▾ Tag value <input type="text" value="0"/> Priority <input type="text" value="0"/> (0~4095) (0~7)	Enable ▾ Tag value <input type="text" value="101"/> Priority <input type="text" value="0"/> (0~4095) (0~7)

Click **OK** on that page to apply the changes.

3. Go to [WAN] > [Internet Access]

Set the **WAN1 Access Mode** to **MPoA / Static or Dynamic IP**, then click the **Details Page** button to proceed:

Auto Logout ▾ Dashboard Wizards Online Status WAN General Setup Internet Access Multi-PVC/VLAN WAN Budget LAN	<p>WAN >> Internet Access</p> <p>Internet Access</p> <table border="1"> <thead> <tr> <th>Index</th> <th>Physical Mode</th> <th>1 Access Mode</th> <th>2</th> </tr> </thead> <tbody> <tr> <td>WAN1</td> <td>ADSL / VDSL2</td> <td>MPoA / Static or Dynamic IP ▾</td> <td>Details Page</td> </tr> <tr> <td>WAN2</td> <td>Ethernet</td> <td>None ▾</td> <td>Details Page</td> </tr> <tr> <td>WAN3</td> <td>USB</td> <td>None ▾</td> <td>Details Page</td> </tr> </tbody> </table>	Index	Physical Mode	1 Access Mode	2	WAN1	ADSL / VDSL2	MPoA / Static or Dynamic IP ▾	Details Page	WAN2	Ethernet	None ▾	Details Page	WAN3	USB	None ▾	Details Page
Index	Physical Mode	1 Access Mode	2														
WAN1	ADSL / VDSL2	MPoA / Static or Dynamic IP ▾	Details Page														
WAN2	Ethernet	None ▾	Details Page														
WAN3	USB	None ▾	Details Page														

4. In the MPoA / Static or Dynamic IP settings:

Select the **Enable** option and select **Obtain an IP address automatically** which will obtain an IP from the ISP using DHCP.

If your ISP has provided a static IP range, with a Network address and a Subnet Mask, specify that with the **Specify an IP address** option.

WAN 1

PPPoE / PPPoA	MPoA / Static or Dynamic IP	IPv6
<input type="radio"/> Enable <input checked="" type="radio"/> Disable		
ADSL Modem Settings Multi-PVC channel: <input type="text" value="Channel 2"/> Encapsulation: <input type="text" value="1483 Bridged IP LLC"/> VPI: <input type="text" value="0"/> VCI: <input type="text" value="101"/> Modulation: <input type="text" value="Multimode"/>		
IP Network Settings <input checked="" type="radio"/> Obtain an IP address automatically More Options <input type="button" value="+"/> <input type="radio"/> Specify an IP address IP Address: <input type="text"/> Subnet Mask: <input type="text"/>		
WAN Connection Detection Mode: <input type="text" value="ARP Detect"/>		
MTU <input type="text" value="1492"/> (Max:1500) <input type="button" value="Path MTU Discovery"/>		
RIP Routing <input type="checkbox"/> Enable RIP		
Bridge Mode <input type="checkbox"/> Enable Bridge Mode <input type="checkbox"/> Enable Full Bridge Mode Bridge Subnet: <input type="text" value="LAN 1"/>		
MAC Address <input checked="" type="radio"/> Default MAC Address		

Click **OK** on this page to apply the changes and the router will then prompt to restart. Click the OK button to restart the router.

- Once the router has restarted, the **[Online Status] > [Physical Connection]** page will display the VDSL information and DHCP connection status, if the WAN1 section shows an IP address, it has connected to the internet successfully:

Auto Logout IPv6

Dashboard
Quick Start Wizard
Online Status
Physical Connection
Virtual WAN

WAN
LAN
NAT
Firewall
User Management
Objects Setting
CSM
Bandwidth Management
Applications
VPN and Remote Access
Certificate Management
Wireless LAN
SSL VPN
USB Application
System Maintenance
Diagnostics
External Devices

Support Area
Product Registration

Online Status

Physical Connection System Uptime: 0:8:44

IPv4		IPv6	
LAN Status	Primary DNS: 194.72.0.98		Secondary DNS: 213.120.234.26
IP Address	TX Packets	RX Packets	
192.168.1.1	0	0	

WAN 1 Status >> [Release](#)

Enable	Line	Name	Mode	Up Time		
Yes	VDSL2		DHCP Client	0:06:58		
IP	GW IP	TX Packets	TX Rate(Bps)	RX Packets	RX Rate(Bps)	
217.34.6.35	217.42.145.215	224580	805	339568	963	

WAN 2 Status

Enable	Line	Name	Mode	Up Time		
Yes	Ethernet		---	00:00:00		
IP	GW IP	TX Packets	TX Rate(Bps)	RX Packets	RX Rate(Bps)	
---	---	0	0	0	0	

WAN 3 Status

Enable	Line	Name	Mode	Up Time	Signal
Yes	USB		---	00:00:00	-
IP	GW IP	TX Packets	TX Rate(Bps)	RX Packets	RX Rate(Bps)
---	---	0	0	0	0

VDSL2 Information (VDSL2 Firmware Version: 8B0F07_A/B/C)

Profile	State	UP Speed	Down Speed	SNR Upstream	SNR Downstream
17A	SHOWTIME	20000 (Kbps)	80000 (Kbps)	15 (0.1dB)	6 (0.1dB)

5.2.3 PPPoA connection with ADSL / ADSL2+

1. Go to [WAN] > [Internet Access]

Set the WAN1 Access Mode to PPPoE / PPPoA and click the **Details Page** button to proceed:

WAN >> Internet Access

Index	Physical Mode	Access Mode	
WAN1	ADSL / VDSL2	PPPoE / PPPoA	Details Page
WAN2	Ethernet	None	Details Page
WAN3	USB	None	Details Page

2. On the PPPoE / PPPoA settings tab:

The details for the **VPI** and **VCI** settings for ADSL should be correct for UK usage, with **0** and **38** being the defaults. In most cases, it will not be necessary to change these.

The **Modulation** setting can be left on its default of Multimode which will auto-detect the correct ADSL type to use.

WAN >> Internet Access

WAN 1

PPPoE / PPPoA | MPoA / Static or Dynamic IP | IPv6

Enable Disable

ADSL Modem Settings

Multi-PVC channel: Channel 1

VPI: 0

VCI: 38

Encapsulating Type: VC MUX

Protocol: PPPoA

Modulation: Multimode

ISP Access Setup

Username: ?3456@HG01.btclick.com

Password: ●●●●●●●●

More Options

PPP/MP Setup

PPP Authentication: PAP or CHAP

IP Assignment (IPCP): Static Dynamic

Fixed IP Address:

WAN IP Alias

Dial-Out Schedule

Index(1-15) in **Schedule** Setup:

None => None

=> None => None

PPPoE Pass-through

For Wired LAN²

For Wireless LAN

Select the **Enable** radio button at the top of the page to ensure that the PPPoA interface is enabled.

Enter the ISP credentials into the **Username** and **Password** fields.

If your ISP has provided a static IP address, that can be specified by setting the **Fixed IP** setting to **Yes** and entering the IP in the **Fixed IP Address** field.

Click **OK** on this page to apply the changes and the router will then prompt to restart. Click the OK button to restart the router.

- Once the router has restarted, the **[Online Status] > [Physical Connection]** page will display the ADSL information and PPP connection status, if the WAN1 section shows an IP address, it has connected to the internet successfully:

Auto Logout IPv6

Dashboard
Quick Start Wizard
Online Status
Physical Connection
Virtual WAN

WAN
LAN
NAT
Firewall
User Management
Objects Setting
CSM
Bandwidth Management
Applications
VPN and Remote Access
Certificate Management
Wireless LAN
SSL VPN
USB Application
System Maintenance
Diagnostics
External Devices

Support Area
Product Registration

Online Status

Physical Connection System Uptime: 0:8:44

IPv4		IPv6			
LAN Status		Primary DNS: 194.72.0.98		Secondary DNS: 213.120.234.26	
IP Address	TX Packets	RX Packets			
192.168.1.1	0	0			

WAN 1 Status >> [Drop PPPoA](#)

Enable	Line	Name	Mode	Up Time		
Yes	VDSL2		PPPoE	0:07:41		
IP		GW IP	TX Packets	TX Rate(Bps)	RX Packets	RX Rate(Bps)
217.34.6.35		217.42.145.215	224580	805	339568	963

WAN 2 Status

Enable	Line	Name	Mode	Up Time		
Yes	Ethernet		---	00:00:00		
IP		GW IP	TX Packets	TX Rate(Bps)	RX Packets	RX Rate(Bps)
---		---	0	0	0	0

WAN 3 Status

Enable	Line	Name	Mode	Up Time	Signal	
Yes	USB		---	00:00:00	-	
IP		GW IP	TX Packets	TX Rate(Bps)	RX Packets	RX Rate(Bps)
---		---	0	0	0	0

VDSL2 Information (VDSL2 Firmware Version: 8B0F07_A/B/C)

Profile	State	UP Speed	Down Speed	SNR Upstream	SNR Downstream
17A	SHOWTIME	20000 (Kbps)	80000 (Kbps)	15 (0.1dB)	6 (0.1dB)



Note

If the WAN 1 IP address displayed begins with 172.16.x.x, it's possible that the ISP has not accepted the supplied Username and Password for the Internet connection.

Check that the ISP Access Setup - Username and Password match the details supplied by your ISP.

5.3 WAN2 – Ethernet Connection Setup

The WAN2 interface of the Vigor 2765 router can connect to an ISP supplied router or another network with an Internet connection.

The Ethernet WAN port is shared with the LAN port P4 and must be configured to operate in WAN mode as shown in section 5.3.1 Enabling the Ethernet WAN Port

If you are using a modem and your ISP has supplied you with a Username and Password to connect to the Internet, see section 5.3.2 PPPoE

If the router is connected to a modem and the ISP does not supply or require a Username and Password to connect to the Internet, or you are connecting to another router or network, see section 5.3.3 Static or Dynamic IP

5.3.1 Enabling the Ethernet WAN Port

The Vigor 2765 series router uses port P4 to connect to an Ethernet based Internet connection. In its default state, the port P4 operates as a standard LAN port and the WAN2 (Ethernet WAN) options cannot be selected in the router's web interface.

To enable the router's Ethernet WAN port on port P4 instead of LAN mode:

1. Go to [WAN] > [General Setup] and click WAN2

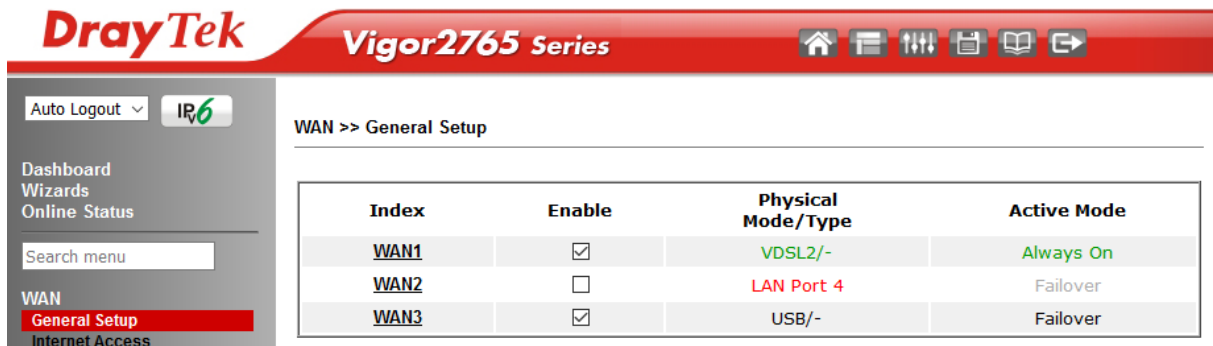

Index	Enable	Physical Mode/Type	Active Mode
<u>WAN1</u>	<input checked="" type="checkbox"/>	VDSL2/-	Always On
<u>WAN2</u>	<input type="checkbox"/>	LAN Port 4	Failover
<u>WAN3</u>	<input checked="" type="checkbox"/>	USB/-	Failover

2. In its default state, the **Enable** option is set to **No**, which uses port P4 as a standard LAN port:

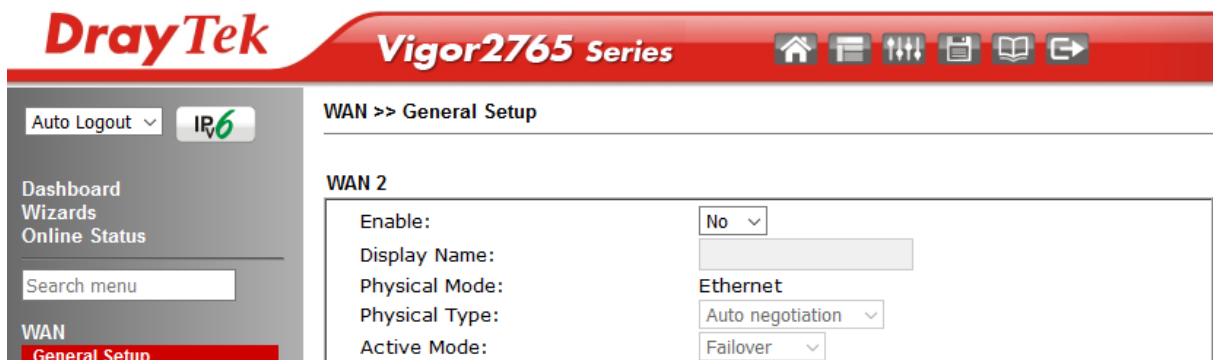

WAN 2

Enable:

Display Name:

Physical Mode: Ethernet

Physical Type:

Active Mode:

- Set the **Enable** option for WAN2 to **Yes**, this enables the other options on this page.
Set the Active Mode to **Always On** to make the Ethernet port the active Internet connection.

The screenshot shows the DrayTek Vigor2765 Series web interface. The top navigation bar includes the DrayTek logo, the model name 'Vigor2765 Series', and several utility icons. On the left, a sidebar menu lists various configuration sections, with 'WAN > General Setup' highlighted in red. The main content area is titled 'WAN >> General Setup' and contains a 'WAN 2' configuration box. Inside this box, the following settings are visible: 'Enable' is set to 'Yes' (dropdown); 'Display Name' is an empty text field; 'Physical Mode' is 'Ethernet'; 'Physical Type' is 'Auto negotiation' (dropdown); 'Active Mode' is 'Always On' (dropdown); 'VLAN Tag insertion' is 'Disable' (dropdown); 'Tag value' is '0' (text field, range 0~4095); and 'Priority' is '0' (text field, range 0~7). At the bottom of the configuration box are 'OK' and 'Cancel' buttons.

- Click OK to apply the change and the router will prompt to restart. Click OK to restart the router.

System Maintenance >> Reboot System

Reboot System

The screenshot shows a 'Reboot System' dialog box with the question 'Do you want to reboot your router ?'. There are two radio button options: 'Using current configuration' (which is selected) and 'Using factory default configuration'.

OK

Once the router has restarted, the WAN2 - Ethernet WAN interface can be configured on the router, as shown in the following two sections.



Note

To reconfigure port P4 for LAN use, go to **[WAN] > [General Setup] > [WAN2]** and set the **Enable** option to **No**.

Once the router has been restarted to apply the change, the port will operate in LAN mode.

5.3.2 PPPoE

This connection method will typically be used with a modem such as the Vigor 130 VDSL2 modem, which passes through the PPPoE connection from the ISP to the router.

1. Go to [WAN] > [Internet Access]

Firstly set the **WAN2 Access Mode** to **PPPoE**, then click the **Details Page** button to proceed:

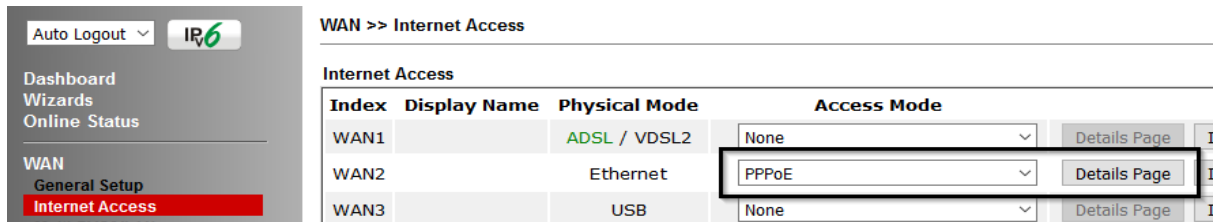

WAN >> Internet Access

Index	Display Name	Physical Mode	Access Mode	
WAN1		ADSL / VDSL2	None	Details Page
WAN2		Ethernet	PPPoE	Details Page
WAN3		USB	None	Details Page

2. In the PPPoE settings tab:

Select the **Enable** radio button at the top of the page to ensure that the PPPoE interface is enabled.

Input the username into the **Username** field and password in the **Password** field, as required. The Service Name does not need to be specified.

If your ISP has provided a static IP address, that can be specified by setting the **Fixed IP** setting to **Yes** and entering the IP in the **Fixed IP Address** field.

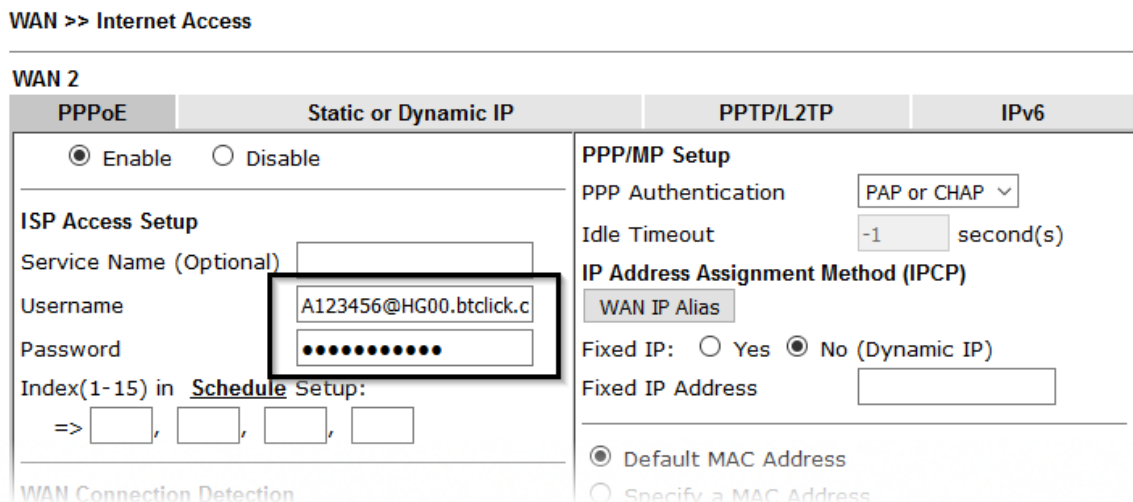

WAN >> Internet Access

WAN 2

Enable Disable

ISP Access Setup

Service Name (Optional)

Username

Password

Index(1-15) in [Schedule Setup](#):
=> , , ,

WAN Connection Detection

PPP/MP Setup

PPP Authentication

Idle Timeout second(s)

IP Address Assignment Method (IPCP)

Fixed IP: Yes No (Dynamic IP)

Fixed IP Address

Default MAC Address
 Specify a MAC Address

Click **OK** on that page to save the settings and the router will then prompt to restart, allow it to restart to properly apply the changes.

Once the router has restarted, log back into the web interface and select **[Online Status] > [Physical connection]**, if it has connected, the relevant **WAN Interface** status text will be in green along with an IP address which indicates that the connection is active and ready for use.

5.3.3 Static or Dynamic IP

1. Go to [WAN] > [Internet Access]

Firstly set the WAN2 Access Mode to Static or Dynamic IP, then click the **Details Page** button to proceed:

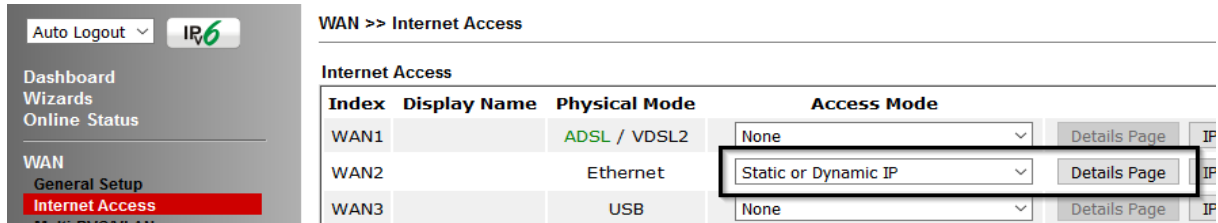

2. In the Static or Dynamic IP settings:

Select the **Enable** option and select **Obtain an IP address automatically** which will obtain an IP from the ISP with DHCP.

If your ISP has provided a static IP range, with a Network address and a Subnet Mask, specify that with the **Specify an IP address** option.

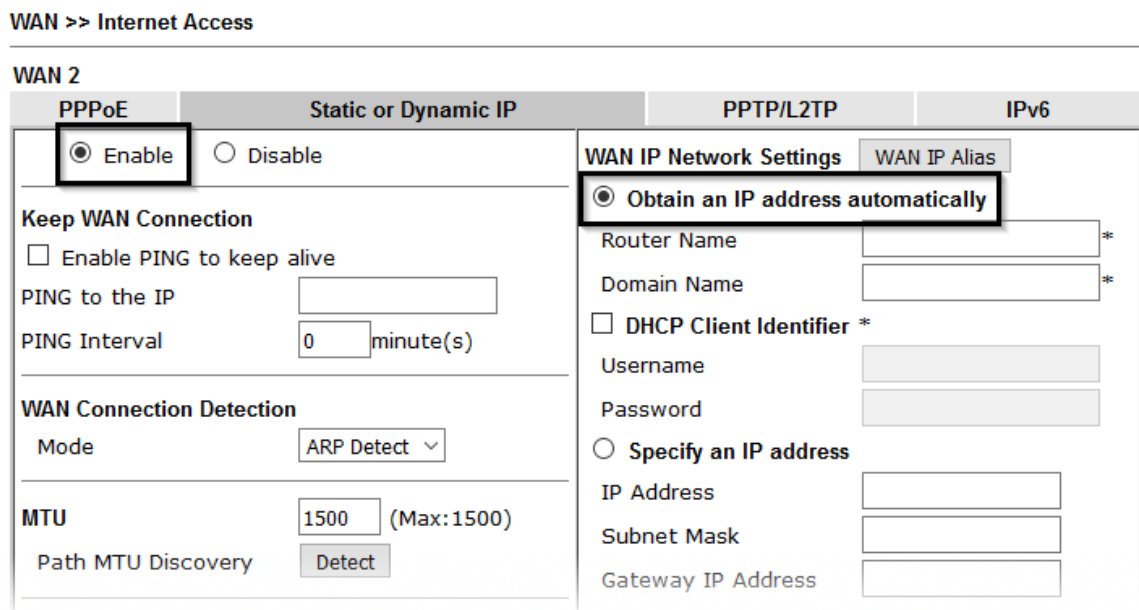

Click **OK** on this page to apply the changes and the router will then prompt to restart. Click to restart the router.

Once the router has restarted, log back into the web interface and select **[Online Status] > [Physical connection]**, if it has connected, the relevant **WAN Interface** status text will be in green along with an IP address which indicates that the connection is active and ready for use.

5.4 WAN3 / WAN4 – 3G / 4G USB Modem Setup

The 3G / 4G USB modem facility can be used either as a primary Internet connection or as a backup that will only activate when other WAN interfaces are offline. It allows a supported USB modem to provide internet access through the router.

The list of supported modems can be found under:
[USB Application] > [Modem Support List]

or on the DrayTek UK site:

<https://www.draytek.co.uk/support/guides/usb-3g-4g-modem-support-list>

There are two USB modem connection modes available:

PPP mode is used where the modem provides a dial-up interface and would typically require software to perform dialing and provide status information and diagnostics when used with a PC.

DHCP mode is used where the modem operates as a virtual network adapter / router and will usually have diagnostics and usage information shown in a web interface.

When configuring the 3G / 4G modem, the router will require the correct **APN** (Access Point Name) details and a username and password with some ISPs. If those details are not set, the mobile network may reject the connection attempts of the router, which will result in the router showing no signal / no IP address.

5.4.1 PPP Mode

To set up the USB WAN for PPP mode, go to **[WAN] > [Internet Access]**
Select **3G/4G USB Modem (PPP mode)** from the drop-down box

Click the **Details Page** button to continue:

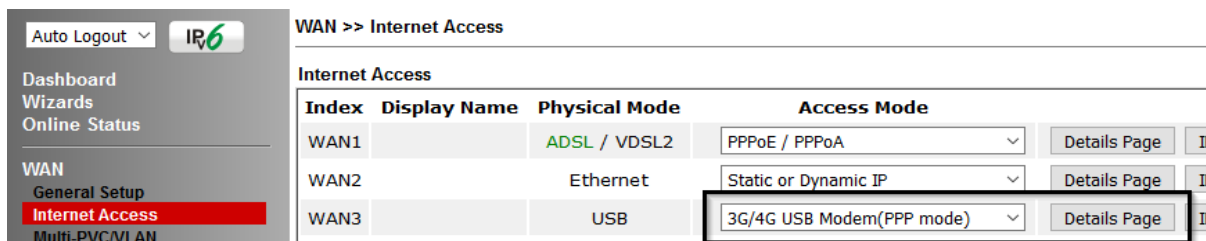

WAN >> Internet Access

Internet Access

Index	Display Name	Physical Mode	Access Mode	
WAN1		ADSL / VDSL2	PPPoE / PPPoA	Details Page
WAN2		Ethernet	Static or Dynamic IP	Details Page
WAN3		USB	3G/4G USB Modem(PPP mode)	Details Page

In the USB WAN settings, select the **Enable** option to enable the WAN interface.

The Modem String values typically do not need to be changed.

Enter the **PPP Username** and **PPP Password** if your ISP requires these to authenticate.

Enter a SIM PIN code only if your SIM card has a PIN set on it, otherwise leave this blank.

WAN 3

3G/4G USB Modem(PPP mode) | 3G/4G USB Modem(DHCP mode) | IPv6 | [Modem Support List](#)

3G/4G USB Modem(PPP mode) Enable Disable

SIM PIN code

Modem Initial String
(Default:AT&FE0V1X1&D2&C1S0=0)

APN Name

Modem Initial String2

Modem Dial String
(Default:ATDT*99#, CDMA:ATDT#777, TD-SCDMA:ATDT*98*1#)

Service Name (Optional)

PPP Username (Optional)

PPP Password (Optional)

PPP Authentication

To set the **APN Name**, enter the APN required by the SIM card / network into the APN Name field and click the **Apply** button:

3G/4G USB Modem(PPP mode) Enable Disable

SIM PIN code

Modem Initial String
(Default:AT&FE0V1X1&D2&C1S0=0)

APN Name

Modem Initial String2

Modem Dial String

This will move the APN Name into the **Modem Initial String** to indicate that it has been saved.

3G/4G USB Modem(PPP mode) Enable Disable

SIM PIN code

Modem Initial String
(Default:AT&FE0V1X1&D2&C1S0=0)

APN Name

Modem Initial String2

Modem Dial String

Click **OK** to save and apply the changes.

If the modem is detected successfully, the WAN interface should be able to connect. Status information can be viewed on the **[Online Status] > [Physical Connection]** section as WAN3. If there is a successful connection, the WAN interface text will show in green and will show an IP address.

5.4.2 DHCP Mode

To set up the USB WAN for DHCP mode, go to **[WAN] > [Internet Access]**
 Select **3G/4G USB Modem (DHCP mode)** from the drop-down box
 Click the **Details Page** button to continue:

WAN >> Internet Access

Index	Display Name	Physical Mode	Access Mode	
WAN1		ADSL / VDSL2	PPPoE / PPPoA	Details Page
WAN2		Ethernet	Static or Dynamic IP	Details Page
WAN3		USB	3G/4G USB Modem(DHCP mode)	Details Page

In the USB WAN settings, select the **Enable** option to enable the WAN interface.
 Enter a **SIM PIN** code only if your SIM card has a PIN set on it, otherwise leave this blank.

Network Mode defaults to **4G/3G/2G** which will auto-select the network type to connect to and will use whichever mode the base station recommends. Setting this to a specific mode will force that connection type, for instance “4G Only” will connect using 4G specifically

The APN Name will typically not need to be set with a USB modem that uses DHCP mode, however if the modem cannot connect then enter the APN for the SIM card used in the modem.

WAN >> Internet Access

WAN 3

3G/4G USB Modem(PPP mode) | 3G/4G USB Modem(DHCP mode) | IPv6 | [Modem Support List](#)

Enable Disable

SIM PIN code

Network Mode **4G/3G/2G** (Default:4G/3G/2G)

APN Name **exampleAPN**

LTE hardware version ---

WAN Connection Detection

Mode **ARP Detect**

MTU **1500** (Default:1500)

Path MTU Discovery **Choose IP**

Authentication **PAP or CHAP**

Username (Optional)

Password (Optional)

Click **OK** to save and apply the changes.

If the modem is detected successfully, the WAN interface should be able to connect. Status information can be viewed on the **[Online Status] > [Physical Connection]** section as **WAN3**. If there is a successful connection, the WAN interface text will show in green and will show an IP address.

6. Getting Further Help

If the router does not appear to be operating correctly or you cannot get online to the Internet, please visit our web site (www.draytek.co.uk) for further troubleshooting advice or to contact our support technicians. Always have your serial number to hand.

Users in the UK/Ireland using qualifying products should visit for support options including email support, telephone support, our help knowledgebase and access to the UK user support forums.

If you are **outside** of the UK/Ireland, please contact your own local supplier, email to support@draytek.com or visit www.draytek.com/support

For warranty service, in the first instance, please contact the support services, as listed above, for help in diagnosing or eliminating the problem or issue. The support department can arrange repair or service if then deemed necessary.

The standard Vigor 2765 series warranty is 'Return to base' (RTB) unless you have VigorCare which provides enhanced services (see www.draytek.co.uk/vigorcure).

You should keep your proof of purchase (original invoice) safely in case warranty or other service is ever required.

6.1 Additional Feature Setup

This is a quick setup guide to get you online with your new router. Your Vigor 2765 series router is capable of very much more and has a plethora of other features.

These are covered in the main user manual, which is available on the Downloads page:

<https://www.draytek.co.uk/support/downloads>

The online knowledgebase has additional information on how to configure the router's Internet connectivity and more advanced features:

<https://www.draytek.co.uk/support/product-knowledgebase>

6.2 Keep up to date with our mailing list

Now that you have your DrayTek product, you should keep up to date with product updates (firmware), security advisories and other product news, advice or special offers. Users in the UK/Ireland can subscribe to our mailing list. For details and to subscribe, please visit

In other countries or regions, please contact your local distributor/supplier for local options.

6.3 Firmware Updates

It is strongly recommended that you keep your router firmware up to date with the latest version in order to have all of the latest security and feature improvements.

Always obtain firmware from official sources, i.e. (for UK/Ireland users).

There are two firmware file types:

.all - upgrade retaining all previous settings

.rst - upgrade and reset to factory default

It is recommended to take a configuration backup prior to upgrading the firmware.

6.4 Security & Router Best Practice

Your router is the gateway to an entire business network and data. Even the best security equipment requires correct usage in order to ensure that its features are effective.

There are many simple practices that every router user should adopt to help reduce the risk to their network or business as well as some very common and simple mistakes that people habitually make - simple mistakes which could then be exploited by others.

We've produced our free guide "**Router Best Practice**" which contains essential information for anyone installing, configuring or using a broadband router or wireless LAN.

Available to download: <https://www.draytek.co.uk/best>