

User Manual

D7C Expansion Module

for Snom D717, D735, D765, D785 phones

TABLE OF CONTENTS

Copyright, Trademarks, Legal Disclaimers	3
Important information	4
Safety instructions	4
Standards conformance	4
SELV (Safety Extra Low Voltage) compliance	4
Product specifications	5
Disposal of the device	5
Cleaning	5
Setting up the expansion module	6
Delivery content	6
Attaching the footstand	6
Connecting the Snom D7C to a Snom phone	7
Connecting two or three D7Cs to a Snom phone	8
Detaching the connector	9
Connecting a wireless headset	9
Getting to Know Your Expansion Module	10
Display Layout	10
SmartLabels	11
Function key LEDs	11
Display appearance settings	12
Configuring the function keys	15
On the phone	15
Font size and text alignment	15
Function settings	15
On the web interface	16
Font size and text alignment	16
Function settings	16
XML provisioning of settings	17
Function key numbering system	20
Firmware update	23
Manual update via the phone's web interface	23
Update via provisioning	23

Copyright, Trademarks, Legal Disclaimers

© 2021 Snom Technology GmbH

All Rights Reserved.

Snom, the names of Snom products, and Snom logos are trademarks owned by Snom Technology GmbH. All other product names and names of enterprises are the property of their respective owners.

Product specifications are subject to change without notice.

Snom Technology GmbH reserves the right to revise and change this document at any time, without being obliged to announce such revisions or changes beforehand or after the fact.

Texts, images, and illustrations and their arrangement in this document are subject to the protection of copyrights and other legal rights worldwide. Their use, reproduction, and transmittal to third parties without express written permission may result in legal proceedings in the criminal courts as well as civil courts.

When this document is made available on Snom's web page, Snom Technology GmbH gives its permission to download and print copies of its content for the intended purpose of using it as a manual. No parts of this document may be altered, modified or used for commercial purposes without the express written consent of Snom Technology GmbH.

Although due care has been taken in the compilation and presentation of the information in this document, the data upon which it is based may have changed in the meantime. Snom therefore disclaims all warranties and liability for the accurateness, completeness, and currentness of the information published, except in the case of intention or gross negligence on the part of Snom or where liability arises due to binding legal provisions.

Important information

Please read the instructions on safety and disposal and on how to set up and use the device before using it and also give them to other users to read or inform those users of their contents. Save this manual and do not give the device to third parties without it.

Safety instructions

Follow the instructions in this manual and other applicable documentation of the device.

- For use with Snom D717, D735, D765, and D785 only. Do not connect the device to a PC or to other phones!
- Mount the device only at heights not exceeding 2m.
- If the device is not supplied with power via the USB cable, use only a power adapter expressly recommended by Snom Technology. Other power supplies may damage or destroy the device, affect its behavior, or induce noise.
- Avoid placing the cables where people may trip over them or where they may be exposed to mechanical pressure as this may damage them.
- This device is for indoor use only! NOT FOR OUTDOOR USE!
- Do not install the device in rooms with high humidity (for example, in bathrooms, laundry rooms, damp basements). Do not immerse the device in water and do not spill or pour liquids of any kind onto or into the device.
- Do not install the device in surroundings at risk for explosions (paint shops, for example). Do not use the device if you smell gas or other potentially explosive fumes.
- Do not use the device during thunderstorms. Lightning striking the power grid may cause electric shocks.

Standards conformance



This device complies with the essential health, safety, and environmental requirements of all relevant European directives. The declaration of conformity can be downloaded at <https://www.snom.com/conformity>.



This device meets the relevant health, safety, and environmental standards of the United Kingdom.

This device meets the relevant health, safety, and environmental standards of the United States and Canada.

Unauthorized opening, changing, or modifying the device will cause the warranty to lapse and may also result in the lapse of CE, FCC, IC, and UK conformity. In case of malfunction contact authorized service personnel, your seller, or Snom.

SELV (Safety Extra Low Voltage) compliance

Safety status of Input/Output connections comply with SELV requirements.

Product specifications

- **Safety:** IEC 62368-1
- **Connectors:**
 - 1 attached USB 2.0 cable with USB standard type A plug;
 - 1 USB port, type A, USB 2.0
 - 1 x 5V DC jack
- **Power:** Via attached USB cable. A power adapter (available separately) is needed **for the second module** which also supplies power to the third module via USB cable. The third module may also need a power adapter if a USB device is connected to its USB port.
 - EU/AU: Ten Pao, model S018BAM0500200, SnomPN 00004393
Phihong, model PSM10R-050
 - US: Ten Pao, model S018BAM0500200, SnomPN 00004446
Phihong, model PSM10R-050
SIL, model SSA-050200US

Disposal of the device



This device is subject to European Directive 2012/19/EU and may not be disposed of with general household garbage.



If you do not know where you may dispose of the device at the end of its lifespan, contact your municipality, your local waste management provider, or your seller.

For countries outside the European Union: Disposal of electrical and electronic products in countries outside the European Union should be done in line with local regulations. Please contact local authorities for further information.

Cleaning

To clean the device, use an anti-static cloth. Please avoid cleaning liquids as they might damage the surface or internal electronics of the device.

Setting up the expansion module

Delivery content

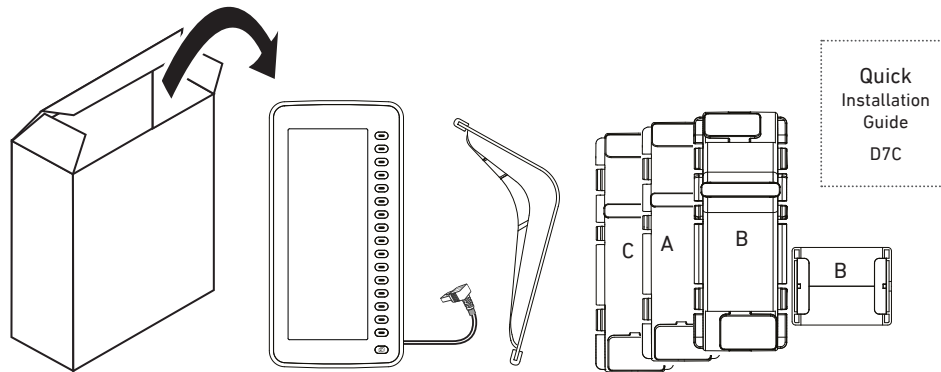

- Base unit with attached USB cable with type A plug
- Footstand
- Connectors: 1 x type A, 2 x type B, 1 x type C
- Quick Installation Guide

Attaching the footstand

1. Place the top of the grooves on the footstand (Fig. 1) below the slideguides on the back of the device (Fig. 2). For the upright position, the short "legs" of the footstand must be attached to the device; for the more horizontal position, use the long ones.
2. Push the footstand upwards onto the slideguides (Fig. 3) until they lock in place (Fig. 4).

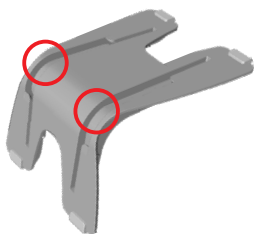

Fig. 1

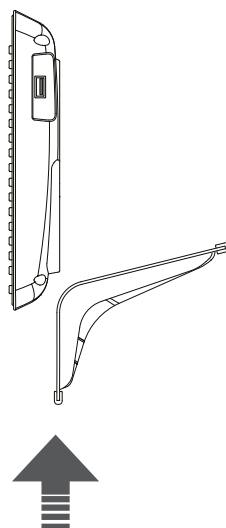

Fig. 2

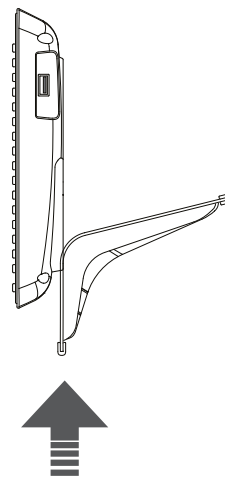

Fig. 3

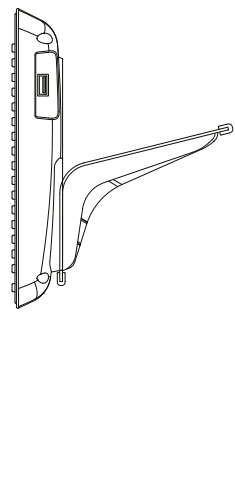

Fig. 4

3. Place the device on an even, horizontal surface.

Connecting the Snom D7C to a Snom phone

The connectors are marked A, B, and C. Connectors A and B are used to attach the footstands of D7C and the phone, connector C is used to connect the footstands of two D7Cs:

- A: connecting to D717, D735, and D765.
- B: connecting to D785. There is also a smaller plate marked B to connect the D7C and the D785 more securely.
- C: connecting a D7C to another D7C.

You can connect up to three Snom D7Cs to one of the supported Snom phones. The first expansion module is supplied with power by the phone via the module's USB cable. The second module is supplied with power by one of the separately available power adapters. The third expansion module is supplied with power by the second module via the third module's USB cable.

Note: In some cases, e.g. if you connect a device requiring a lot of power to the USB port of the D7C, you may also need to attach a power adapter to the third and the first module in the daily-chain.

1. Place a soft cloth on the desktop so that the display does not get scratched or otherwise damaged if you lay the device down.
2. Attach the respective footstand to the D7C expansion module and to the phone.
3. Place the USB cable of the D7C into the cable guide (Fig. 1).

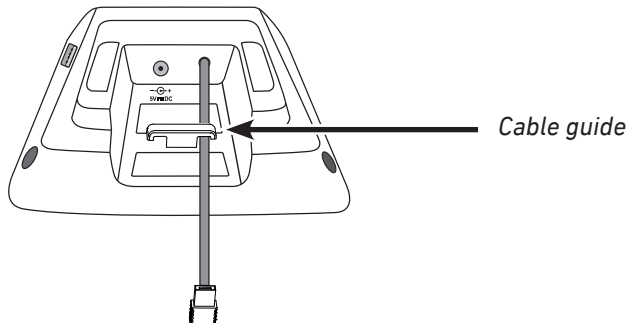

Fig. 1

4. Connect the expansion module to the phone, as shown in Fig. 2. If the phone has two USB ports (Fig. 3), either one can be used.

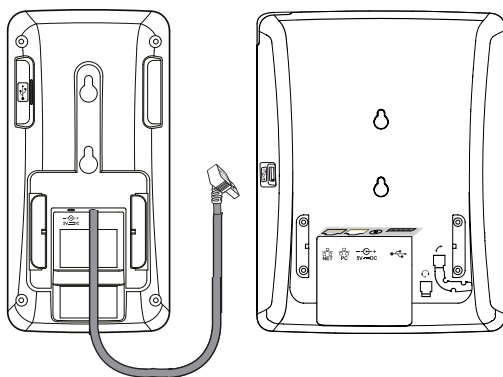

Fig. 2

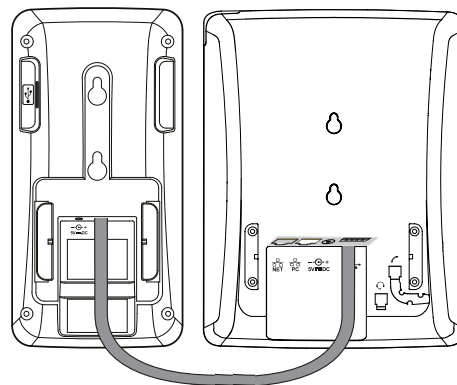

Fig. 3

5. Holding the D7C and the connector backside up, push the connector against the footstand of the DC7 (Fig. 4). If it does not snap securely into place, push the three levers on the connector towards the footstand of the D7C until you hear each one click into place (Fig. 5).

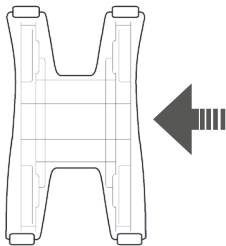

Fig. 4

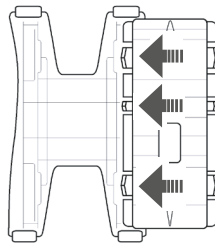

Fig. 5

6. Push the other side of the connector against the footstand of the phone. If it does not snap securely into place, push the three levers on the connector towards the footstand of the phone until you hear each one click into place.
7. **D785 only.** Place a soft cloth on the desktop and turn phone and D7C backside up. On either side of the small plate marked B there is a ridge (Fig. 6) that fits into the slideguides on the footstands. Insert the ridges into the slideguides of the footstands of phone and D7C and slide the connector down toward the tips of the "legs" (Fig. 7).

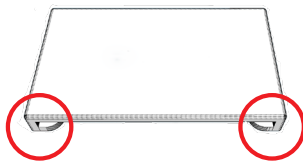

Fig. 6

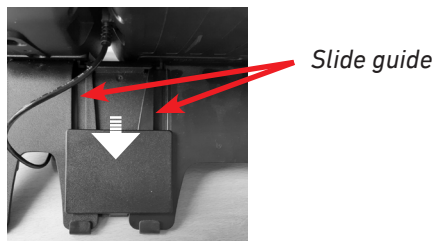

Fig. 7

Connecting two or three D7Cs to a Snom phone

Do not use a USB hub (Fig. 8). If the phone has more than one USB port, **do not** connect expansion modules to more than one port (Fig. 9). **The D7Cs must be daisy-chained.** If they are not, the phone will not be able to identify the function keys on the modules, rendering them inoperable.

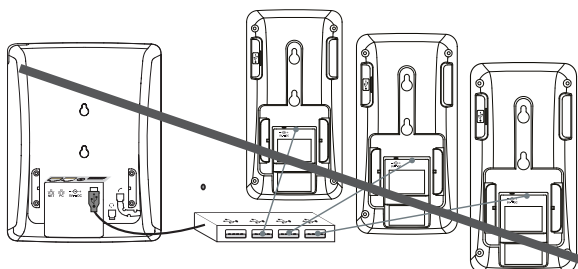

Fig. 8

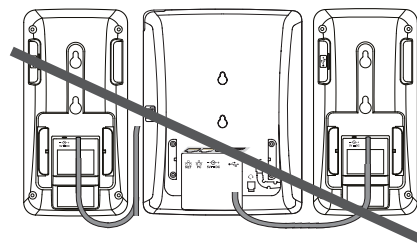

Fig. 9

1. Connect the modules to each other first. If a module is connected to the phone already, connect the second and third module to each other.
2. **Important note:** Attach a power adapter (available separately) to the second module and to a wall outlet **before** connecting the daisy-chain to the phone or the second / second and third module to the D7C already connected to the phone (Fig. 10).

If a USB device like a speakerphone or conferencing device is connected to the third module in the chain, it may also need a power adapter that must be connected to a power outlet.

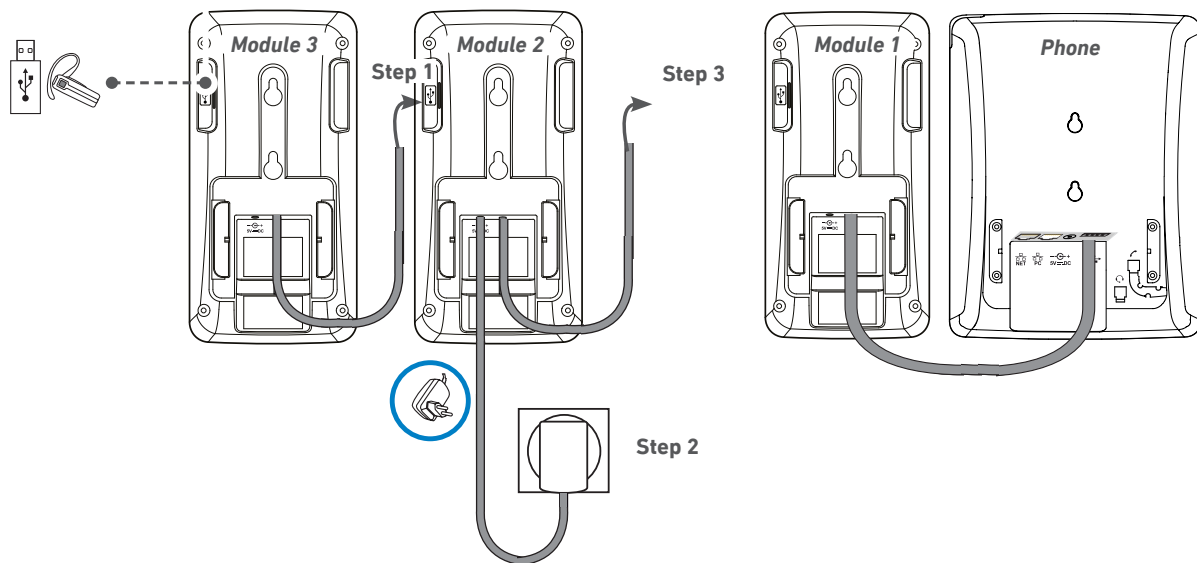
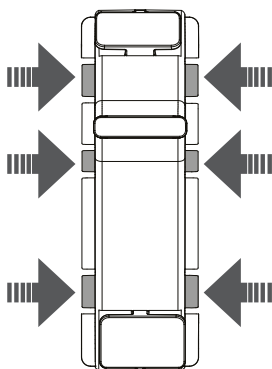

Fig. 10

3. After the modules have been connected to the phone, their LEDs will light up briefly, then turn off, indicating that the function keys are now ready for use..

Detaching the connector

Push the three levers on the respective side inward to detach the connector from the footstand.



Connecting a wireless headset

On phones with a single USB port, the USB port on the expansion module can be used to connect a wireless headset via its USB adapter. If two or three expansion modules are daisy-chained, insert the USB adapter of the wireless headset into the USB port on the last module in the chain,

If the Snom phone has two USB ports, the USB adapter of the wireless headset can be inserted into the USB port on the expansion module **or** into the free USB port on the phone.

Getting to know your D7C

The function keys on the expansion module(s) are configured and work like function keys/SmartLabel keys with LEDs on the phone itself. The settings are stored on the phone and will remain stored there when the expansion module is disconnected; if the expansion module is replaced by another module, the settings will be used by that module. For more information on the available functions and on how to program and use the keys, please refer to the phone's manual, chapter "Programming the Function Keys". You can download the manual at <https://service.snom.com> -> **Desk Phones**.

Display layout

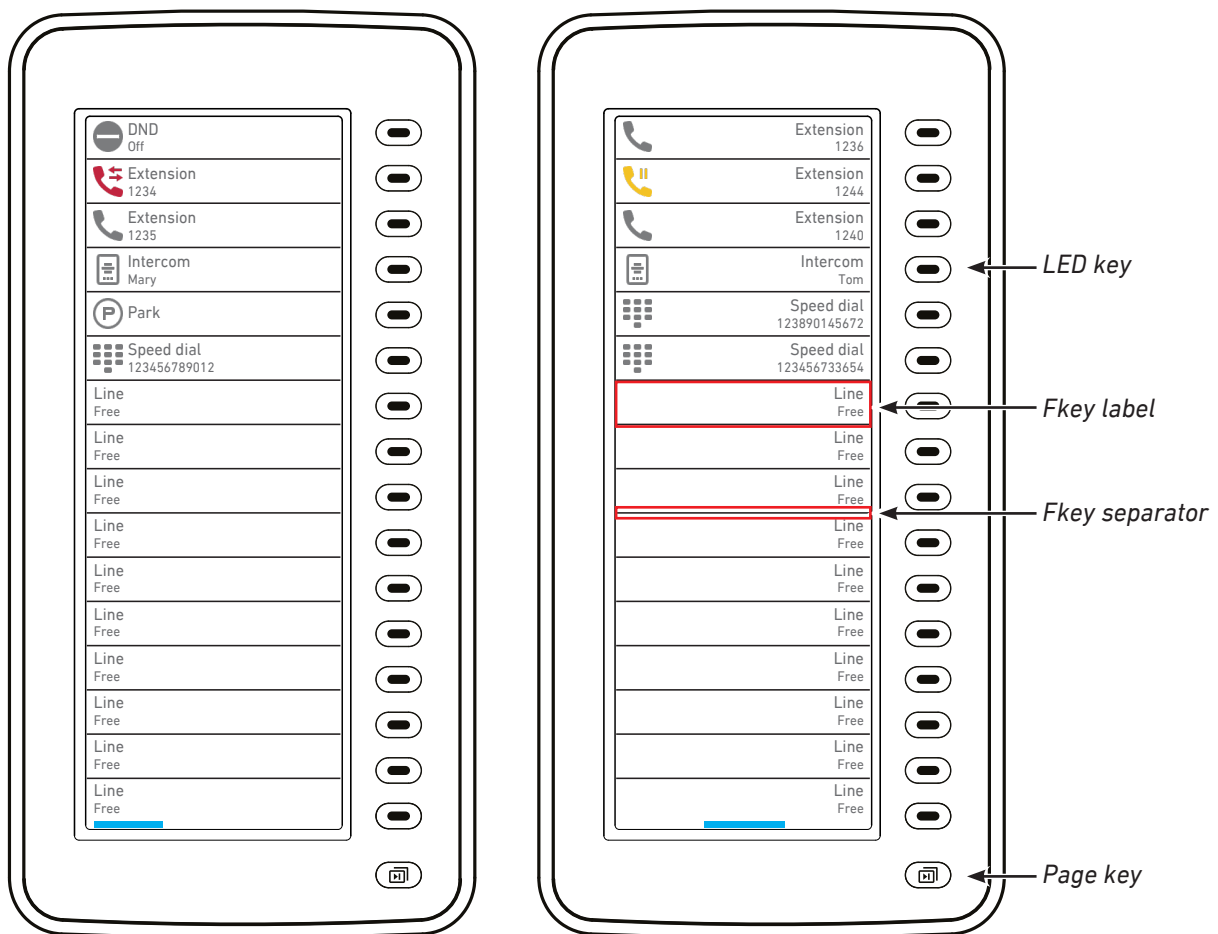



Fig. 1

Fig. 2

The module has 16 function keys with LED  and a page key  for scrolling through the three function key pages. A field on the display screen is allocated to each key, and the text can be left-aligned, as shown in Fig. 1, or right-aligned, as shown in Fig. 2. The blue line at the bottom of the screen indicates which page is on-screen (Fig. 3).

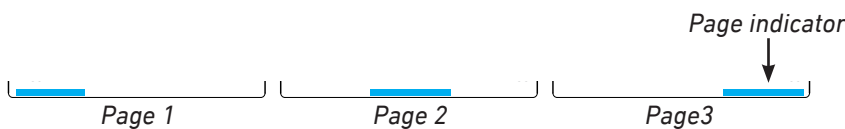

Fig. 3

SmartLabels

In the default setting, icon and name of the function type are shown in the label area (Fig. 1 and 2, example 1).

- When no text has been entered in the **Label** field and the **Number** field is empty, the label area on the display shows the function type (example 1).
- When a text is entered in the **Label** field, it is displayed instead of the function type (example 2, 4, and 5).
- When a value is entered in the **Number** field and the **Label** field is empty, the value is added as a second line to the function type in the top line (example 3).
- If you want two lines of character strings to be displayed, for example a name and a phone number for an extension setting, enter them in the **Label** field with the
 tag between them (example 5).

Context	Type	Number	Label
Active	Extension		
Active	Extension		Joe Miller
Active	Extension	1236@example.com	
Active	Extension	1236@example.com	Joe Miller
Active	Extension	1236@example.com	Joe Miller 1236

Fig. 1





 Extension	1
 Joe Miller	2
 Extension 1236	3
 Joe Miller	4
 Joe Miller 1236	5
Line Free	

Fig. 2

Note: The label is a convenience for the user. It has no effect on the functioning of the key. Examples 1 and 2 are not valid extension settings because no **Number** value has been set.

Depending on the function mapped onto the key, its allocated display area will show the context information when the key event occurs or when the key is pressed; it will revert to the idle content when the key event has ended or when the key is pressed again.





 Extension 1234	Extension idle	 DND Off
 Extension 1234	Extension ringing	
 Extension 1234	Extension busy	 DND On

Fig. 3

Function key LEDs

Depending on the function mapped onto the key, the LEDs on the key will light up when the key event occurs or when the key is pressed; they will go out when the key event has ended or when the key is pressed again.

Display appearance settings

The D7C comes with four standard background themes (UI color themes) that can be selected on the phone and on the phone's web interface (Fig. 1 to 4); the default is the "light" theme at Fig. 1. The color of label separators, text, and symbols is adjusted automatically for best readability on the background.

Per provisioning only, you can also specify the URL to a custom background image to be used instead (Fig. 5 and 6). For custom backgrounds with a light background or a mixed background like Fig. 5 you may also need to set the **industrial** UI color theme to improve the readability of the text.

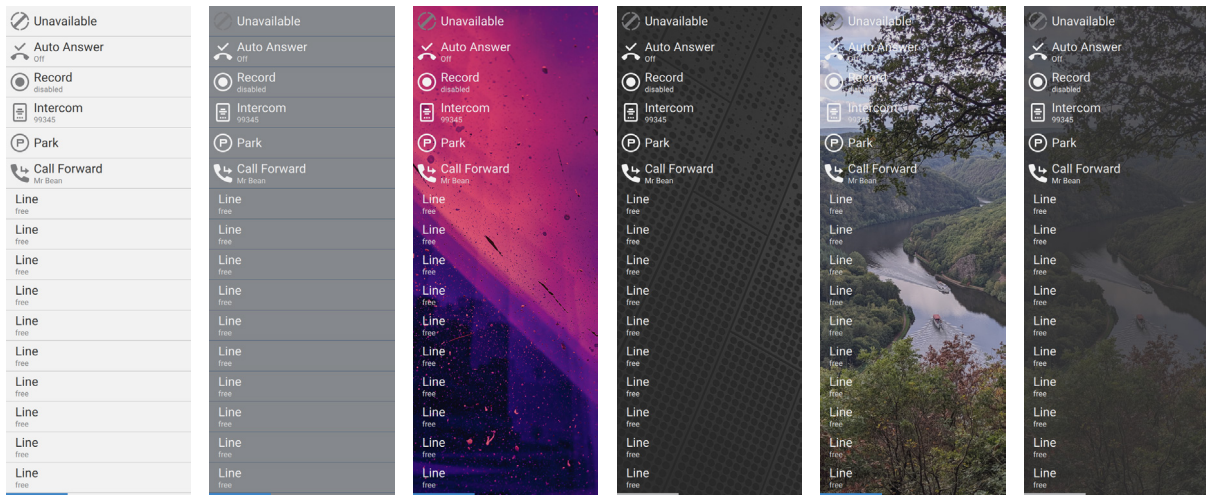

Fig. 1–light

Fig. 2–dark

Fig. 3–colorful

Fig. 4–industrial







Fig. 5

Fig. 6





The intensity of the backlight can be adjusted separately for periods of activity and inactivity. When the device has been inactive for a specified number of seconds, it will automatically switch the backlight intensity to idle mode.

Settings on the phone



UI color theme

1. Press  to open the **Settings** menu of the phone that the module is connected to.
2. Select **Preferences** and press .
3. Select **Display** and press .
4. Select **Expansion Modules** and press .
5. Select **Appearance** and press .
6. Select the module if more than is connected to the phone.
7. Select a theme and press  to save and return to the **Expansion Modules** menu.

Backlight

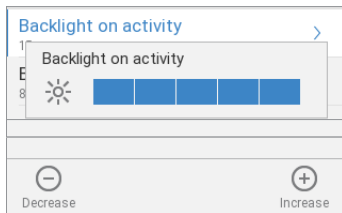
1. Press  to open the **Settings** menu of the phone that the module is connected to.
2. Select **Preferences** and press .
3. Select **Display** and press .
4. Select **Expansion Modules** and press .
5. Select **Backlight on activity** or **Backlight when idle** and press .



6. Press the right or left arrow on the navigation key or the function key underneath  or  in the function key line to decrease or increase the backlight's intensity.
7. Press  to save and return to the **Expansion Modules** menu.

Note: The timer for returning the backlight to idle mode is set on the web interface.

Settings on the web interface

UI color theme

1. Open the web interface of the phone.
2. Click **Preferences** in the menu on the left side of the window.
3. Click the **Appearance** tab.
4. Scroll down to **UI Color Theme** and select a theme from the drop-down menu.

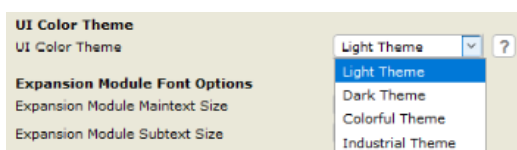

5. Click **Apply** and **Save**.

Custom image

1. Open the web interface of the phone.
2. Click **Preferences** in the menu on the left side of the window.
3. Click the **Appearance** tab.
4. Scroll down to **Expansion Module Interface Elements** and enter the URL to a custom image. Image size must be 480 by 1280 pixels, and the file size should be below 2MB. If the image does not conform to these specifications, the current UI color theme will be instead used instead.

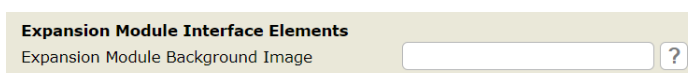

5. Click **Apply** and **Save**.

Backlight

1. Open the web interface of the phone.
2. Click **Preferences** in the menu on the left side of the window.
3. Click the **Display** tab.

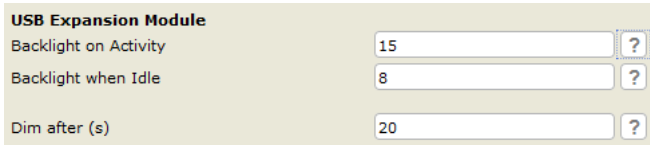

The screenshot shows a section titled "USB Expansion Module" with three settings:

Setting	Value	Help
Backlight on Activity	15	?
Backlight when Idle	8	?
Dim after (s)	20	?

4. In the **USB Expansion Module** section, enter a value from 0 to 15 in the text fields of **backlight on activity** and **backlight when idle**. The defaults are 15 (highest intensity) for backlight on activity and 8 for backlight when idle. Enter 0 to turn the backlight off.
5. Enter a time period in seconds in the text field of **Dim after (s)**. Valid values are integers from 1 to 2147483647. The default is 20 seconds.
6. Click **Apply** and **Save**.

Configuring the function keys

The function keys on the expansion module are configured and work like the SmartLabel keys with LEDs on the D717, D735, and D785 and the function keys with LEDs on the D765. The settings are stored on the respective phone and remain stored there when the expansion module is disconnected. They are not shown in the phone's settings when no expansion module is connected. If the expansion module is replaced by another module, the settings will be used by that module.



The keys on the D7C are freely programmable function keys. See the phone's manual, chapter **Configuring the function keys**, for the description of the settings and how to configure them. You can download the manual at <https://service.snom.com> +.

Configuration on the phone



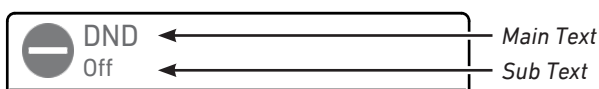

Font size and text alignment











The font size of the upper (MainText) and lower (SubText) text lines can be adjusted separately.



1. Press  to open the **Settings** menu of the phone that the module is connected to.
2. Open the **Preferences** menu.
3. Open the **Display** menu.
4. Open the **Expansion Modules** menu.
5. Open **Appearance**.
6. Select the UXMC expansion module.
7. Select the font size for the top line (*Maintext size*) and the bottom line (*Subtext size*). The defaults are XL and S, respectively.
8. Select the text alignment. The default is left-aligned.
9. Press  for 3 seconds to return to the idle screen.

Function settings

1. Press  to open the **Settings** menu of the phone that the module is connected to.
2. Open the **Preferences** menu.
3. Open the **Fkeys** menu.
4. Select the **UXMC** expansion module.
5. Select **Page 1**, **2**, or **3**, respectively, by scrolling to the respective page and pressing .
6. Select a key and press  to open the **Key # Function** menu. The selected key flashes yellow if the SmartLabel key page with the key to be configured is on-screen (press  to page).

7. The default for **Context** is *Active*, i.e., all configured identities whose status is "active".
 - a. If you want to restrict the functionality to a configured identity, select **Context** and press .
 - b. Select the identity from the menu and press . The following prompts depend on the selected functionality.
8. Select **Type** and press . Use **▼** / **▲** to scroll to a functionality on the list and press . The information you will then be prompted to enter depends on the selected functionality.
9. In our example, the functionality is *Extension*. Press  to select and return to the **Key # function** menu where **Number** has been added to the menu below "Type".
10. Select **Number** and press .
11. Enter the extension number and press .
12. The **Label** is optional. See "SmartLabels" on page 11 for more information. Enter a name or other descriptive text and press , or press  without entering data to save.
13. Press  briefly to return to the **Key # Function** menu; press  for 3 seconds to return to the idle screen.

Configuration on the web interface

Font size and text alignment

1. Open the web interface of the phone.
2. Click **Preferences** in the menu on the left side of the window.
3. Click the **Appearances** tab.
4. Scroll down to **Expansion Module Font Options** and select font size and text alignment from the respective drop-down menus. The defaults are XL for Main Text and S for Sub Text size, and left-aligned for the text alignment.

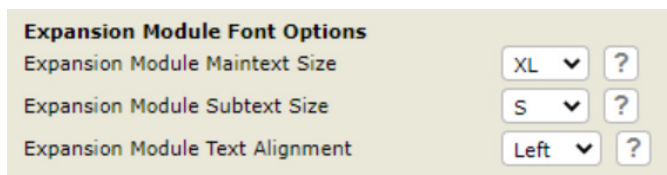

5. Click **Apply** and **Save**.

Function settings

1. Open the web interface of the phone.
2. Click **Function keys** in the menu on the left side of the window. The keys on the three pages of each module are numbered consecutively from 1–48 on each module:
 - Page 1: 1–16
 - Page 2: 17–32
 - Page 3: 33–48

Expansion Module 1				
Page 1				
Context	Type	Number	Label	XML Label
Active	Line			1
Active	Line			2
Active	Line			3

Page 2				
Context	Type	Number	Label	XML Label
Active	Line			17
Active	Line			18
Active	Line			19

Page 3				
Context	Type	Number	Label	XML Label
Active	Line			33
Active	Line			34
Active	Line			35

- Click the **Key Assignment** tab, if necessary.
- Scroll down to **Expansion Keys** and the expansion module you want to configure.
- Under **Context** of the key you want to configure, select "Active" or one of the configured identities from the drop-down list. The default is "Active", i.e., the configured key is available for all configured identities on the phone.
- Under **Type**, select "Extension" from the drop-down list.
- In the **Number** text field, enter the phone number whose calls you want to monitor and pick up.
- Optional: In the **Label** text field, enter a name or descriptive text. See "SmartLabels" on page 11 for more information.
- Click **Apply** and **Save**.

XML provisioning of settings

The XML tags of the function keys are an exception from the general rules for XML mass provisioning of settings for Snom phones because the tag for each key specifies the exact settings for that particular key. The format is as follows:

```
<fkey idx="n" context="active" label="x" default_text="$name $state" perm="">argument</fkey>
```

Example:

```
<fkey idx="33" context="active" short_label_mode="text" short_label="" short_default_text="!!$(:)!!$(generate_via_conditional_label_short)" label_mode="icon_text" icon_type="" reg_label_mode="icon_text" label="" lp="on" default_text="!!$(:)!!$(generate_via_conditional_label_full)" perm="" c="1" cslm="1" clm="1">dest &lt; ;sip:14147356@192.168.10.60;user=phone&gt;</fkey>
```

For more information on function key types, see <https://service.snom.com/display/wiki/Function+Key+Types>. For more information on valid values and defaults, see the individual settings at <https://service.snom.com/display/wiki/Settings>.

- Parameter **fkey idx**. The unique identifier of the function key when connected to a particular phone model.
 - NOTE:** The **fkey idx** of a particular key depends on the number of function keys on the phone, the number of expansion modules connected to the phone, and the position of the module in the daisy chain. For your convenience, we have prepared a table of the numbering system; please see "Function key numbering system" on page 20.
- Parameter **context**. This setting specifies the identity (account) that can use the key. The default is Identity 1. Valid settings:
 - All active identities (accounts) registered on the phone: Setting "active".
 - One identity specified by its number. Example: Setting "1" for Identity 1.
- Parameter **label**. The label (name, etc.) to be shown on the expansion module's display. On the **Function Keys** page of the phone's web interface this is the string entered in the text field of **Label**. See "SmartLabels" on page 11.

Examples for an extension setting.

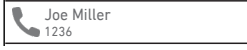
- label="Joe Miller" displays 
- label="Joe Miller
1236" displays two lines: 
- Parameter **default_text**. Optional attribute that can be any string. When the parameter **label** is not set for a key, the value of **default_text** will be displayed as the key's label on the display of the D7C (see "Display layout" on page 10). You can define an arbitrary fixed text or use \$name, \$state, and \$type to insert dynamic information. The default value is "\$name \$state".
 - \$name: Inserts the label or, if label is not set, the extension/phone number supplied as the key's argument.
 - \$state: Inserts the key's state (free, busy, etc.) when functions like line or extension are mapped onto the key.
 - \$type: Inserts the key type.
- Parameter **perm**. Valid values are:
 - perm="!": The settings of the key can be changed by mass provisioning, but only if the end user has not made changes to the configuration on the phone itself or on its web interface.
 - perm="&", perm="R", perm=" ": The settings of the key are Read Only and cannot be changed by the end user.
 - perm="\$", perm="RW", perm="": The settings of the key can be changed by mass provisioning; any end user configurations will be overwritten on reboot.
- Argument**.
 - The default is line. Example:

```
<fkey idx="19" context="1" label="" default_text="$name $state" perm="">line</fkey>
```
 - Examples for other functions:
 - NOTE:** These settings depend on the requirements of the PBX.
 - Extension:

```
<fkey idx="19" context="1" label="Mary" default_text="$name $state" perm="">dest sip:123@example.com;user=phone</fkey>
```
 - Speed dial:

```
<fkey idx="20" context="1" label="Mary/cell" default_text="$name $state" perm="">speed
```

9175550240</fkey>

- Multicast: <fkey idx="21" context="1" label="Announcements 2nd floor" default_text="\$name \$state" perm="">multicast 239.255.255.232:5555</fkey>
- Intercom: <fkey idx="22" context="1" label="Intercom Mary" default_text="\$name \$state" perm="">icom sip:123@example.com;user=phone</fkey>
- Forwarding all incoming calls: <fkey idx="23" context="1" label="Fwd all to Mary" default_text="\$name \$state" perm="">redirect sip:123@example.com;user=phone</fkey>
- Transferring call: <fkey idx="24" context="1" label="Transfer" default_text="\$name \$state" perm="">transfer</fkey>

Function key numbering system

Definitions

- fkey idx: XML mass provisioning
- PUI: Phone user interface (Settings > Preferences > Fkeys)
- WUI: Web user interface (Function Keys page). The keys on the three pages of each module are numbered consecutively on each module:
 - Page 1: 1–16
 - Page 2: 17–32
 - Page 3: 33–48

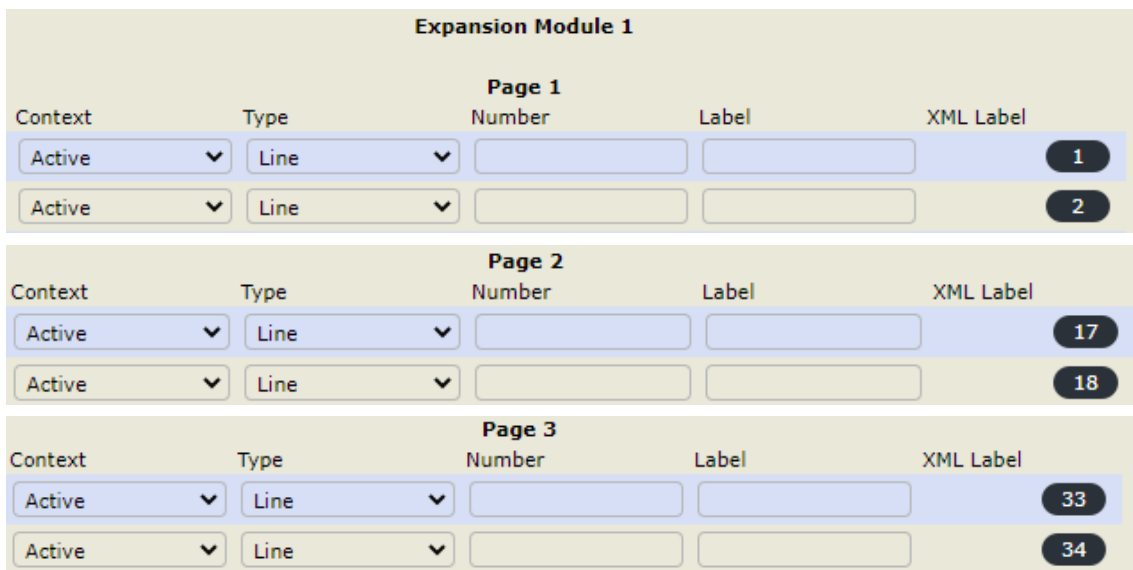

D717

- SmartLabel keys on phone
 - fkey idx: 0–2
 - PUI: 1–3
 - WUI: P1–P3

- D7C expansion module 1

Page 1	fkey idx	3–18	PUI	4–19
Page 2	fkey idx	19–34	PUI	20–35
Page 3	fkey idx	35–50	PUI	36–51

- D7C expansion module 2

Page 1	fkey idx	51–66	PUI	52–67
Page 2	fkey idx	67–82	PUI	68–83
Page 3	fkey idx	83–98	PUI	84–99

- D7C expansion module 3

Page 1	fkey idx	99–114	PUI	100–115
Page 2	fkey idx	115–130	PUI	116–131
Page 3	fkey idx	131–146	PUI	132–147

D735

- SmartLabel keys on phone: fkey idx 0–31, PUI fkey number 1–32
 - Page 1: fkey idx 0–7
PUI 1–8
WUI P1–P8
 - Page 2: fkey idx 8–15
PUI 9–16
WUI P9–P16
 - Page 3: fkey idx 16–23
PUI 17–24
WUI P17–P24
 - Page 4: fkey idx 24–31
PUI 25–32
WUI P25–P32

- D7C expansion module 1

Page 1	fkey idx	32–47	PUI	33–48
Page 2	fkey idx	48–63	PUI	48–64
Page 3	fkey idx	64–79	PUI	65–80

- D7C expansion module 2

Page 1	fkey idx	80–95	PUI	81–96
Page 2	fkey idx	96–111	PUI	97–112
Page 3	fkey idx	112–127	PUI	113–128

- D7C expansion module 3

Page 1	fkey idx	128–143	PUI	129–144
Page 2	fkey idx	144–159	PUI	145–160
Page 3	fkey idx	160–175	PUI	161–176

D765

- Freely programmable function keys on phone
 - fkey idx: 0–15
 - PUI: 1–16
 - WUI: P1–P16

- D7C expansion module 1

Page 1	fkey idx	16–31	PUI	17–32
Page 2	fkey idx	32–47	PUI	33–48
Page 3	fkey idx	48–63	PUI	

- D7C expansion module 2

Page 1	fkey idx	64–79	PUI	65–80
Page 2	fkey idx	80–94	PUI	81–95
Page 3	fkey idx	95–110	PUI	96–111

- D7C expansion module 3

Page 1	fkey idx	111–126	PUI	112–127
Page 2	fkey idx	127–142	PUI	128–143
Page 3	fkey idx	143–158	PUI	144–159

D785

- SmartLabel keys on phone: fkey idx 0–23, PUI key number 1–24
 - Page 1: fkey idx 0–5
PUI 1–6
WUI P1–P6
 - Page 2: fkey idx 6–11
PUI 7–12
WUI P7–P12
 - Page 3: fkey idx 12–17
PUI 13–18
WUI P13–P18
 - Page 4: fkey idx 18–23
PUI 19–24
WUI P19–P24

- D7C expansion module 1

Page 1	fkey idx	24–39	PUI	25–40
Page 2	fkey idx	40–55	PUI	41–56
Page 3	fkey idx	56–71	PUI	56–71

- D7C expansion module 2

Page 1	fkey idx	71–87	PUI	72–88
Page 2	fkey idx	88–103	PUI	89–104
Page 3	fkey idx	104–119	PUI	105–120

- D7C expansion module 3

Page 1	fkey idx	120–135	PUI	121–136
Page 2	fkey idx	136–151	PUI	137–152
Page 3	fkey idx	152–167	PUI	153–168

Firmware update

Manual update via the phone's web interface

- The phone must be running firmware 10.1.64.14 or higher.
 - The name of the update's file must have the format `snomD7C-<version>-r.bin`.
 - The file must be located on a server that can be reached by your phone.
 - Update the expansion modules one at a time.
 - Before the update, disconnect other modules from the phone.
1. Connect the expansion module you want to update to your phone. Wait until its LEDs have lit up and gone out and the labels are shown on the display.
 2. Open the phone's web user interface.
 3. Click **System Information** in the menu on the left side of the window, and confirm that the number of the USB expansion module is 1.

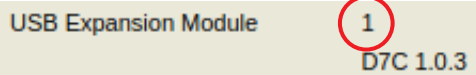

USB Expansion Module 1
D7C 1.0.3

4. Click **Software Update** in the menu on the left side of the window.
5. Enter the HTTP URL to the update file into the **Firmware** text field of the **Manual Expansion Module Software Update** section and click **Load**.

Manual Expansion Module Software Update:

Firmware:

?

Load

The progress of the update is shown on the phone's display. When it is finished, phone and expansion module will reboot.

6. After the reboot, click **System Information** again to check whether the new firmware version is displayed in the line below the module number.

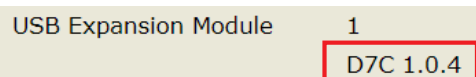

USB Expansion Module 1
D7C 1.0.4

Update via provisioning

- The phone must be running firmware 10.1.64.14 or higher.
- The name of the update file's name must have the format `snomD7C-<version>-r.bin`. An example for the expansion module firmware syntax can be found at <https://service.snom.com/display/wiki/Firmware+Update+XML+Settings>.
- The file must be located on a server that can be reached by your phone.
- The phone's update policy settings must be `auto_update` (**update automatically**) or `ask_for_update` (**ask for update**, i.e., the user receives a prompt to confirm the update).
- Update the expansion modules one at a time.

- Before the update, disconnect other modules from the phone.

Note: After an update via provisioning, the `firmware_uxm` parameter is set to the phone's URL to keep the phone from repeatedly downloading the update file and updating the expansion module. If you are provisioning updates for more than one D7C from the same phone, you must replace the phone's URL in the `firmware_uxm` parameter with the update file's URL before updating the next module.

1. Connect the expansion module you want to update to your phone. Wait until its LEDs have lit up and gone out and the labels are shown on the display.
2. Set the `firmware_status` setting to the update file's HTTP URL. The progress of the update is shown on the phone's display. When the update has been completed, phone and expansion module will reboot.
3. Repeat for each module to be updated.

Snom Technology GmbH
Wittestr. 30 G
13509 Berlin, Deutschland
office.de@snom.com
<https://www.snom.com>

VTech Communications Inc.
Snom Americas
9020 SW Washington Square Road, Suite 555
Tigard, OR 97223, U.S.A.
Phone support: (339) 227 6160
Email support: supportusa@snom.com

VTech Technologies Canada Ltd.
Suite 222, 13888 Wireless Way
Richmond, British Columbia
Canada V6V 0A3
Phone support: (339) 227 6160

Snom Technology GmbH
130, avenue Joseph KESSEL
78960 Voisins-Le-Bretonneux, France
Tel. +33 1 85 83 00 15
Fax +33 1 80 87 62 88
office.fr@snom.com

Snom Technology GmbH
Via Milano 1
20020 Lainate, Italia
Tel. +39 02 00611212
Fax +39 02 93661864
office.it@snom.com

Snom Technology GmbH
The Courtyard, High Street
Ascot, Berkshire SL5 7HP, U.K.
Tel. +44 134 459 6840
Fax +44 134 459 7509
office.uk@snom.com

Your specialist retailer - Ihr Fachhändler -
Votre distributeur - Su distribuidor - Il tuo rivenditore:

⌞

⌞

⌞

⌞