

Nearity

Microphone Solution

User Manual

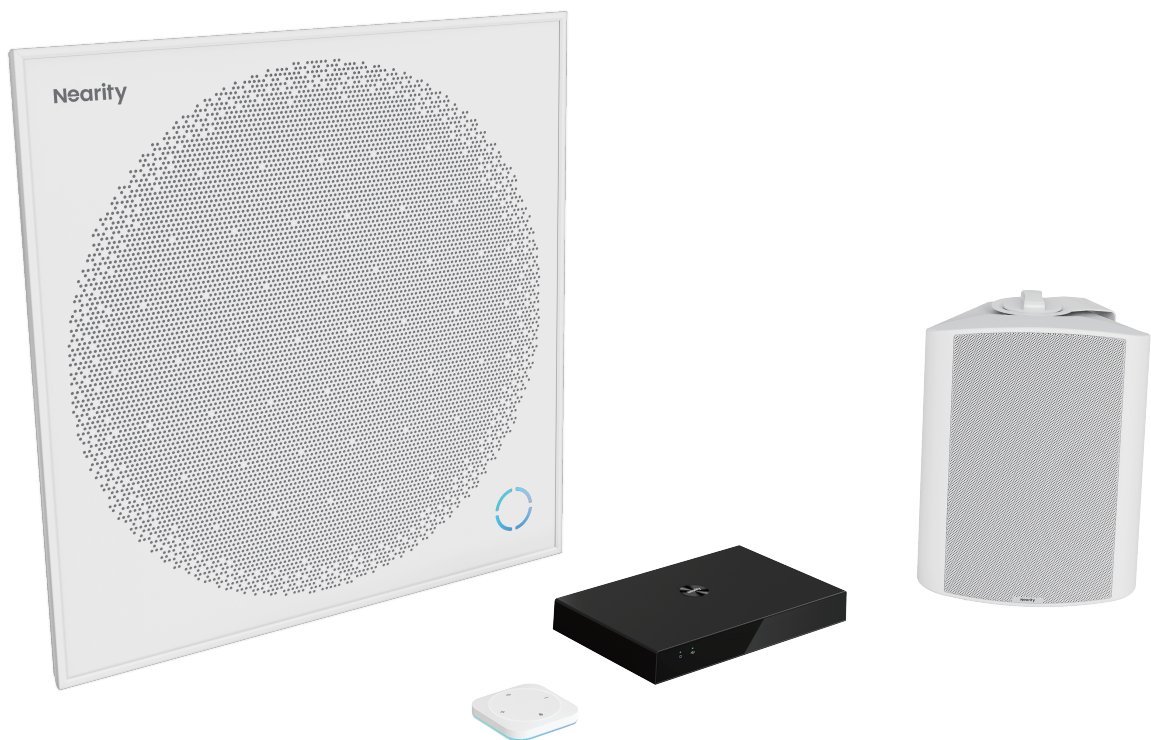

Model: AW-A50

V1.0

Content

1. A50 Product Introduction	01
1.1 A50 Ceiling Microphone Array Solution Introduction	01
1.2 Features	01
1.3 Packing List	01
1.4 A50 Physical Structure	02
1.5 A50 Key Specification	03
2. AMX100 Introduction	04
2.1 A50 Product Overview	04
2.2 Features	04
2.3 Packing List	04
2.4 AMX100 Physical Structure	05
2.5 A50 Key Specification	05
3. ACT10 Introduction	06
3.1 ACT Product Overview	06
3.2 Packing List	06
3.3 ACT10 Connecting AMX100	07
3.4 ACT10 Key Specification	07
4. ASP110 Passive Speaker Introduction	19
4.1 ASP110 Product Overview	08
4.2 Packing List	08
4.3 ASP110 Connecting AMX100	09
4.4 ASP110 Key Specification	09

5. A50 System Deployment Instructions	09
5.1 Installation precautions	10
5.2 System connection	11
5.3 AMX100 Installation position/mode	12
5.4 Installation of A50 Unit	15
5.5 Deployment of ASP110	17
5.6 ACT10 Installation	17
5.7 3rd A/V system integration	17
6. Operation on Software-Nearsync Configuration	18
6.1 Download and Installation of Nearsync	18
6.2 Software Configuration	19
7. FAQ	27
8. Caution	27

1. A50 Product Introduction

● 1.1 A50 Ceiling Microphone Array Solution Introduction

NEARITY A50 is an integrated ceiling microphone solution for video conferencing and in-room audio. Using a 91-element microphone array and deep sidelobe beamforming, advanced AI driven signal processing ensures that every word is clear- from huddle rooms to audience halls.

The solution include A50 Microphone, AMX100 DSP, ACT10 Control, and ASP110/ASP100 Speaker.

● 1.2 Features

- Smart AI Tracking for Meeting Freedom and Presentation Freedom

91 element MEMS microphones and deep sidelobe beamforming pick up sound for up to 12 independent lobes.

- AI driven audio processing

Automatically detects even moving presenters in on their voices for amplification, broadcast, or both.

- Eliminate office clutter

Integrated design allows you to eliminate traditional conference equipment, leaving more room to share and work.





- Experience premium studio-quality video like a pro

Up to eight units A50 daisy-chain via POE to extend your audio reach and cover large spaces.

- Deep-learning AI trained to distinguish human voice from other noise

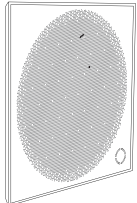
Embedded with onboard digital signal processor, Nearity A50 applies deep-learning AI capabilities, including advanced audio technologies such as audio mixing routing, echo cancellation, noise reduction, and automatic gain control, ensuring vivid speech in a wide area.

● 1.3 Packing List

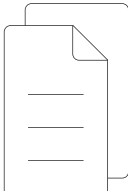
					
Array mic*1	Stainless Steel Rope Components*4	Eyebolts*4	Tapping screw+ Expansion screws*4	Ethernet cable*1	User Manual * 1

● 1.4 A50 Physical Structure

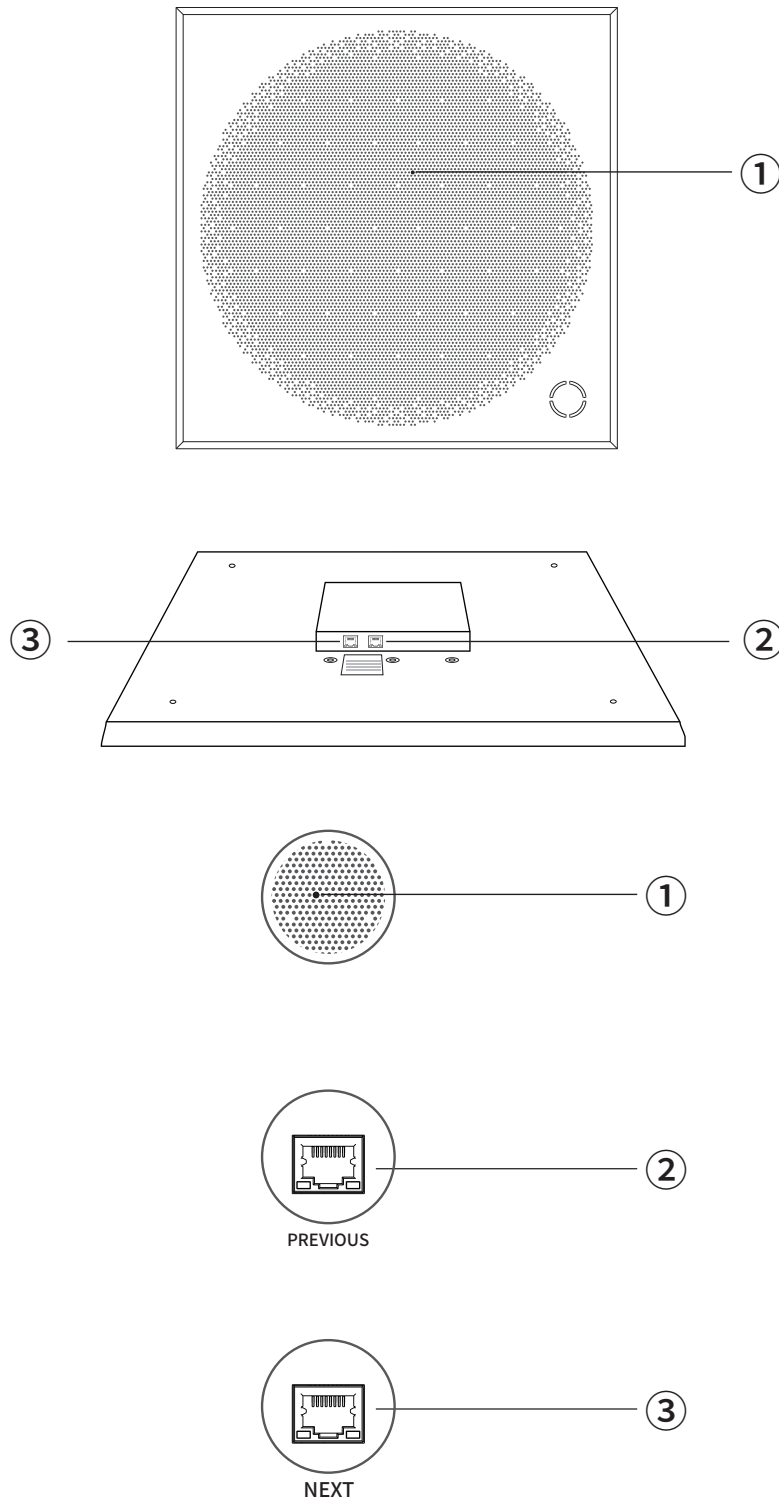

① Reset button--Factory Reset (press button for longer than 3 seconds)

② PREVIOUS--RJ45(Input)

③ NEXT--RJ45(Output)

● 1.5 A50 Key Specification

	Technical Specifications
Microphone Features	91 MEMS microphone array
	Effective pickup range: 10m x 10m(33ft x 33ft)
	Sensitivity: -38dBV/Pa 94dB SPL@1kHz
	SNR: 63dBV/Pa 94dB SPL@1kHz,A-weighted
Audio Characteristics	12 deep sidelobes beamforming
	AI noise suppression
	Full-duplex
	Full-duplex
	Smart reverbration
	Feedback suppression
	Automatic Gain Control(AGC)
Working Modes	Local sound reinforcement / Remote conference / Hybrid mode
Daisy-chain	POE via UTP cable(CAT6)
	Up to 8 units
Product dimension	Height: 45.4mm(1.79 inches) Width: 603mm(23.74 inches) Length: 603mm(23.74 inches)
Installation options	Aspect ratio: 16:9
Connectivity	YUV: max of 480P@30fps
Power	MJPEG: max of 1080P@30fps
Color	H264: max of 2160P@30fps

2. AMX100 Introduction

● 2.1 A50 Product Overview

NEARITY AMX100 DSP is a necessary component for the ceilingmic modes(A40/A50). Its rich interfaces support the connection of loudspeakers, PCs, wireless microphones, ACT10 controllers and other devices. At the same time, it can be compatible with traditional MCU conference rooms, and easily apply to various conference scenes.

● 2.2 Features

- Flexible signal routing and connectivity

3.5mm analog audio in/out and TRS port to connect to room A/V conferencing system; USB-B port to connect to laptop or room PC; USB-C port to connect to additional microphone; phoenix ports to connect with loudspeakers, up to 8.



- Power over Ethernet (PoE) for the ceilingmics power supply:

Automatically detects even moving presenters in on their voices for amplification, broadcast, or both.

- Eliminate office clutter

The AMX100 can connect local wireless microphones and passive speakers to form a simple and fast local sound reinforcement system, and transmit wireless microphone sound to the remote participants via USB.

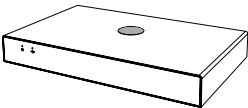
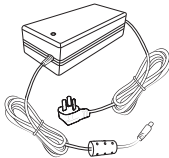
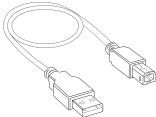
● 2.3 Packing List

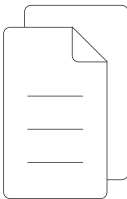
				
AMX100*1	Power adapter*1	USB Type B to Type-A cable*1	Speaker adapter*2	User Manual * 1

● 2.4 AMX100 Physical Structure

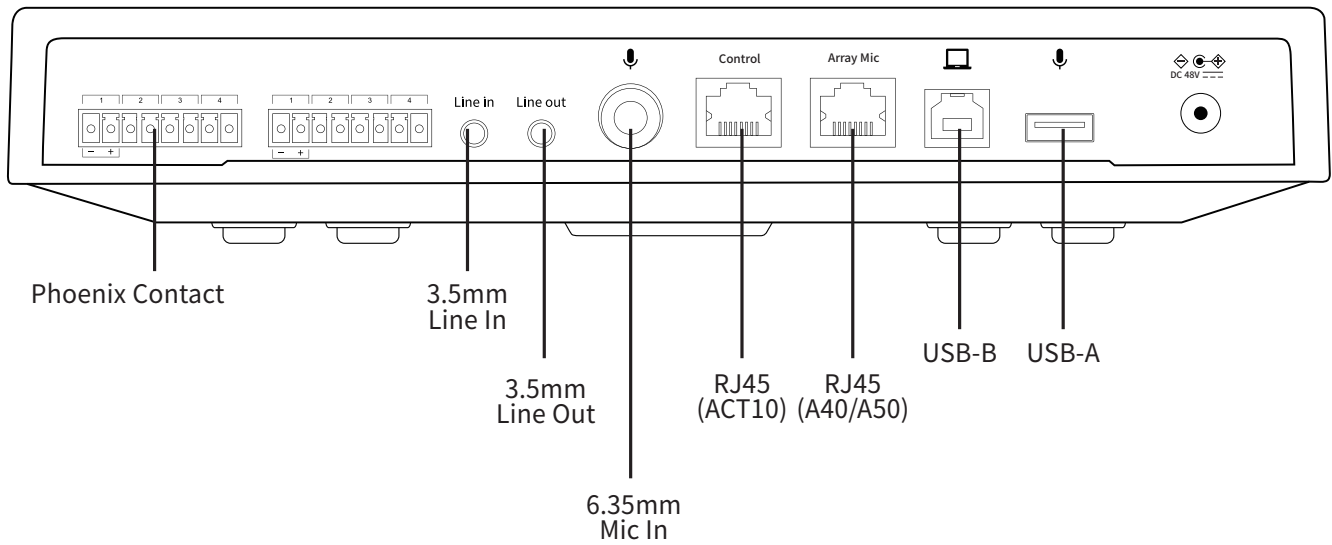

● 2.5 A50 Key Specification

Power and Connectivity	Speaker Interface : Phoenix*8
	Line in : 3.5mm analog in
	Line out : 3.5mm analog out
	TRS : 6.35mm analog in
	Controller : RJ45 connect to ACT10
	Array Mic : RJ45 connect to Nearity ceilingmic, up to 8 via Daisy-chain
	USB-B : Type-B 2.0 connect ro PC
	USB-A : Type-A 2.0
	Power : DC48V/5.2A
Reset : Reset button	
Physical Characteristics	Dimension : 255.4(W) × 163.8(D) × 45.8(H)mm (10.05x 6.45x 1.8inches)

3. ACT10 Introduction

● 3.1 ACT Product Overview

ACT10 is one of the accessories of the ceiling microphone system, which can be installed according to the meeting needs. ACT10 can intelligently control the corresponding ceilingmic device, quickly switch the volume up/down and mute on/off functions by touching the button, and support the one button mode to turn on/off local sound reinforcement mode.



● 3.2 Packing List

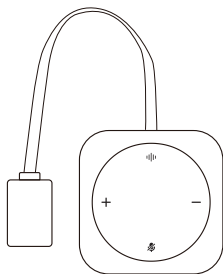

ACT10 * 1

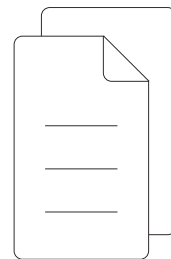

User Manual * 1

● 3.3 ACT10 Connecting AMX100

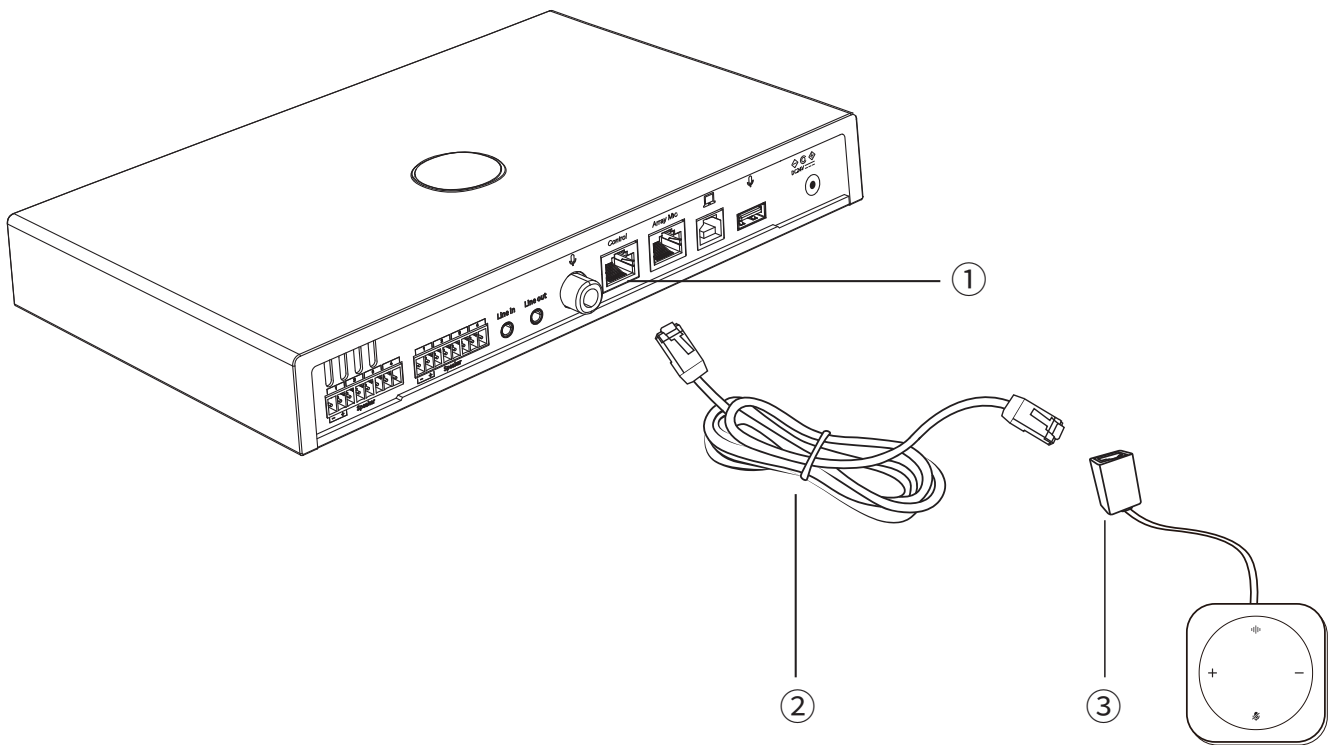

- ①RJ45(Control)
- ②Ethernet cable*
- ③RJ45

* Please purchase the corresponding length of Ethernet cable according to the needs of the scene.

● 3.4 ACT10 Key Specification

Desktop controller buttons	Volume+	Volume up
	Volume-	Volume down
	Microphone mute	Mute on/off
	Mode switch	Sound reinforcement/ Video conference
Desktop Controller Interface	RJ45	Connect to the DSP

4. ASP110 Passive Speaker Introduction

● 4.1 ASP110 Product Overview

ASP 110 is a loudspeaker that provides enterprise sound in the room. By working with NEARITY DSP AMX 100, ASP 110 gives the best audio quality to any conference.

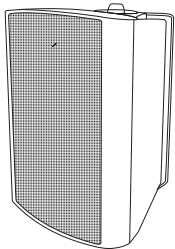
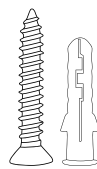
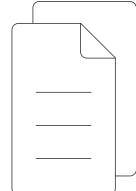

● 4.2 Packing List

		
ASP110*1	Screws*2	User Manual * 1

● 4.3 ASP110 Connecting AMX100

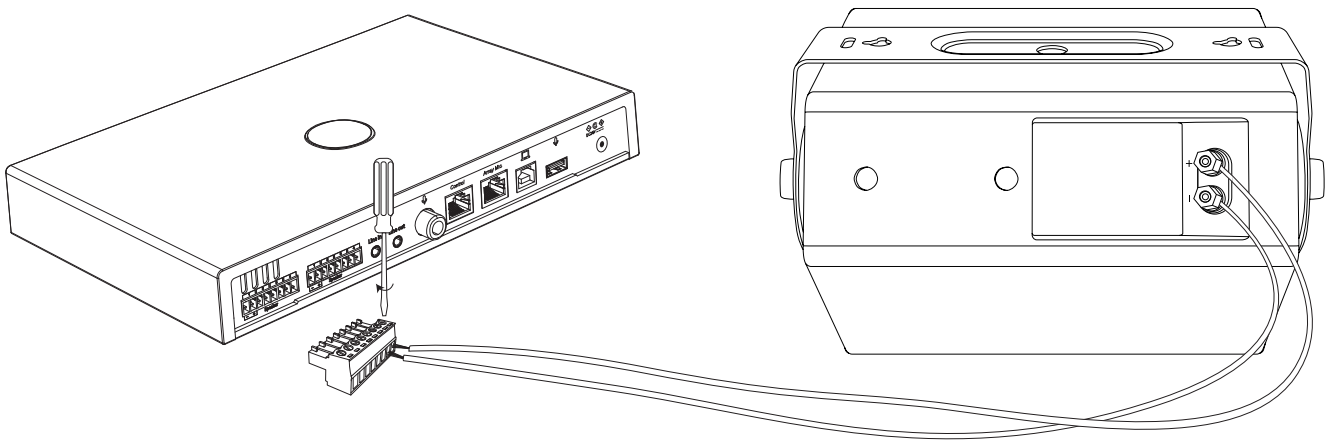

● 4.4 ASP110 Key Specification

Dimension	185(W)*167(D)*250(H)mm (7.28*6.57*9.84 inches)
Rated output power	15W
Effective frequency range	F0-20KHz
Volume	88±3dB @ 1m
THD	<5%

5. A50 System Deployment Instructions

● 5.1 Installation precautions

This product should be installed by a professional contractor. When determining the installation location and method, be sure to consider the applicable laws and ordinances for the area where the product is being installed.

Nearity assumes no responsibility in the event of accidents such as the product dropping due to insufficient strength of the installation site or improper installation.

When working in an elevated location, be sure to choose a stable location with no loose items on the ground before working.

Install the product in a location where there is no risk of the product being hit or damaged by the movements of nearby people or equipment.

Be sure to verify the strength of the installation location. The installation location should generally be able to handle at least 10 times the weight of the product.

Depending on the structure of the ceiling, vibrations may cause noise to be generated. Appropriate separate damping measures are recommended.

Be sure to use only the included accessories for installation.

Do not use the included accessories for any purpose other than for use with this product. Do not install the product in areas with exposure to high levels of oil or smoke, or where solvents or solutions are volatilized. Such conditions may result in chemical reactions that lead to deterioration or damage of the product's plastic parts, which may cause an accident such as the product dropping from the ceiling.

Do not install the product in areas where damage from salt or corrosive gas may occur. Such damage may reduce the strength of the product and cause an accident such as the product dropping from the ceiling.

Be sure to tighten the screws properly and completely. Failing to do so may result in injury due to an accident such as the product dropping from the ceiling.

Do not pinch the cables during installation.

Securely attach the seismic cable, zip tie, and safety belt in the specified location.

Attach the seismic cable so that there is as little slack as possible.

If the impact from a fall is applied to the seismic cable, replace the cable with a new one.

● 5.2 System connection

Compared with other products, the A50 product deployment is more complicated, which should be combined with other audio parts to work as a package, and needs to be integrated with the existing A/V system in customer conference rooms in many cases.



● 5.3 AMX100 Installation position/mode

Generally, AMX100 is installed behind the TV, under the conference table, in the cabinet, etc. However, as AMX100 is the HUB node of each component of the A50 package, it involves:

- Network cable length and cabling mode with multiple A50s.
- Audio cable length and wiring mode with multiple wall mounted louder-speakers ASP110.
- Length and cabling method of USB cable with conference host terminal/smart white-board OPS/speaker's laptop.
- Length and cabling mode of audio cable integrated with equipment in A/V cabinet (if there' s 3rd party A/V system integration).
- The length and cabling mode of the audio cable integrated with the traditional video conference terminal (if there' s 3rd party conference system integration).

Therefore, it is necessary to consider and determine the installation location of the AMX100 by integrating the above factors.

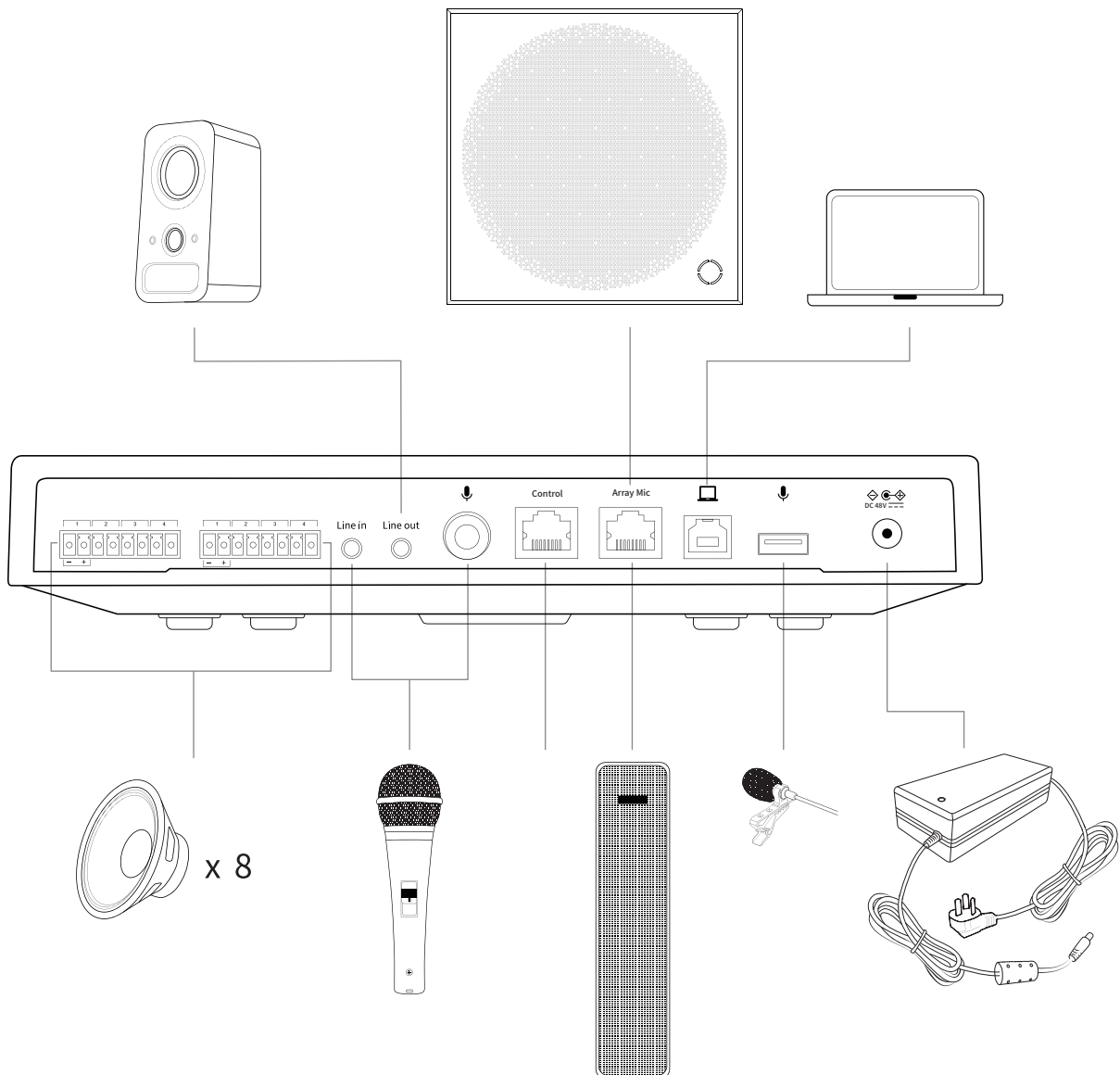

5.3.1 Cable length/cabling

When connecting with A/V system (audio processor/mixer/handheld microphone receiver) and hardware video terminals, the AMX100 side will use unbalanced 3.5 audio interfaces and 6.35 audio interfaces. But the other side is usually a balanced Canon interface and Phoenix terminal interface. Therefore, additional 3.5/6.35 XLR, 3.5/6.35 Phoenix terminal and other conversion cables need to be prepared (pay attention to male and female at both ends).

In addition, due to strong electric magnetic leakage, quality of interconnecting cables, potential difference between two devices and other factors, unbalanced signals are easily to get interference and generate current noise. In this case, it is necessary to purchase a noise eliminator isolator to be connected in series in the interconnection cable to solve the problem of current noise. Such as



PS: The 6.35mm input port will be designed to balanced type the next batch of production.

● 5.4 Installation of A50 Unit

5.4.1 Power supply of A50

A50 is a non-standard PoE power supply mode. The RJ45 port of the AMX100 directly supplies power to multiple A50s, eliminating the need to reserve strong electricity for them in the ceiling.

Cable length/cabling

The AMX100 is equipped with a 20-meter Cat6 network cable as standard, which is used to connect the first A50.

Each A50 is equipped with a 10-meter Cat6 network cable as standard, which is used to connect the subsequent A50.

The length of the standard AMX100/A50 network cable can meet the requirements of

common conference room space. If the cable length in the package is not long enough for some super large conference space, then we can use longer Cat6 and above network cables (well-known brand). Before using the network cable, the line sequence must be tested with a line measuring instrument.

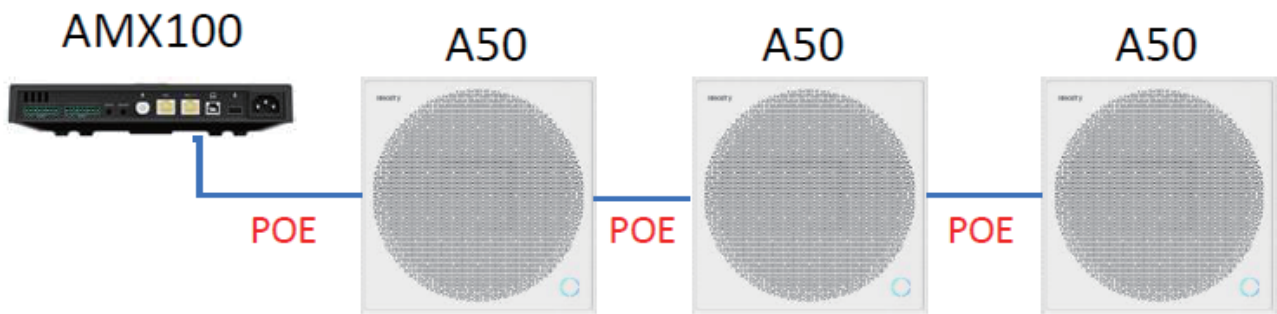

A50 Daisy Chain, up to 8

As we tested, AMX100 support maximum 8 units of A50 cascaded by 8 20-meter Cat6 network cables with all functions work normally.

5.4.2 Installation position/mode

Installation position

The A50 should be installed above the speaker area/conference table where sound pickup is required. The number of A50 is determined according to the length and width of the pickup area and the A50 pickup radius.

Installation method

The A50 supports the following installation methods:

- Wire rope lifting

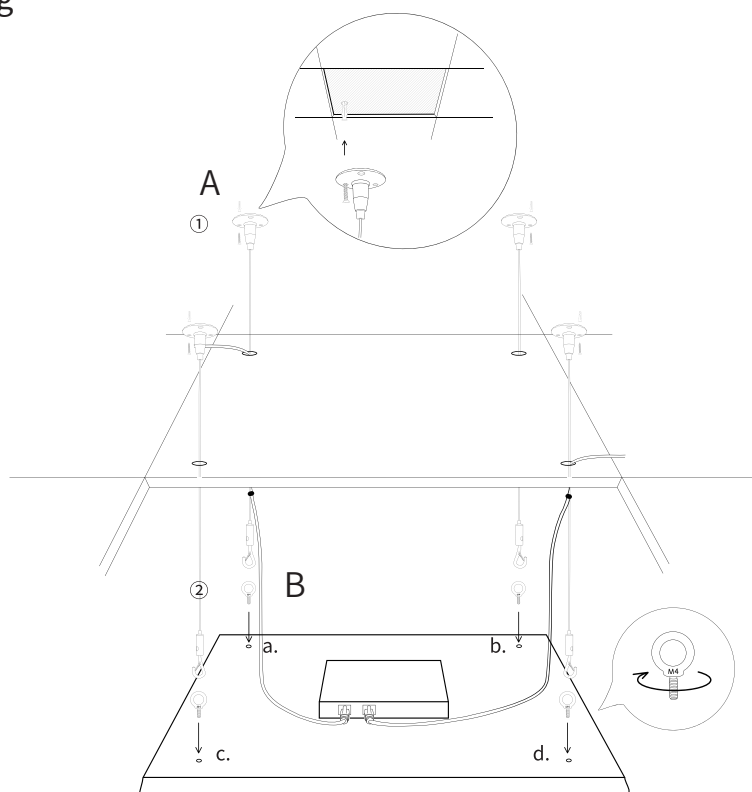

The installation method shall be determined on site according to the actual ceiling conditions and customer requirements.

Pay attention to the customer's ceiling material, load bearing and the existing equipment installed on the ceiling, as a reference for the subsequent A50 installation.

5.4.3 Installation height/angle of A50 Unit

Installation height

A50 support in ceiling, VESA-lifting and lifting mounting. And the recommended height is 2.5~4.5 meters

In general meeting rooms, the ceiling height is usually around 3.0 meters, and the lifting height of A50 is also below this. The current default pickup angle of the A50 is 120°. The lower the lifting height of the A50, the smaller the pickup radius. Therefore, A50 shall be installed as close to the ceiling as possible.

Beam angle

The current default beam angle of A50 is 120°, namely the included angle between the pickup beam and the vertical line of A50 center point is 60°.

The A50 includes 12 beams. Currently, the NearSync tool only supports enable or disable these beams. The following figure shows the direction of the select-able beam relative to the A50 panel (in the picture, the A50 indicator is aligned with the lifting A50 indicator), and the corresponding beam can be checked and enabled in the NearSync tool as required (checked by default, namely enabled). For some application scenarios, for example, in the classroom the A50 only picks up the teacher's voice but not the student's voice, the beam facing the student side can be disabled (unchecked); in the local sound reinforcement scene, the beam pointing to the louder speaker can be disabled (unchecked).

In addition, if there is no special requirement, it is recommended to turn off the beam directly below (No.12 beam) to improve the signal-to-noise ratio and sound quality.

5.4.4 Pickup radius/distance

If the height of A50 is determined, the beam pickup angle is determined (currently fixed at 60°), then the pickup radius is determined. The following is the relationship between the pickup radius and the lifting height:

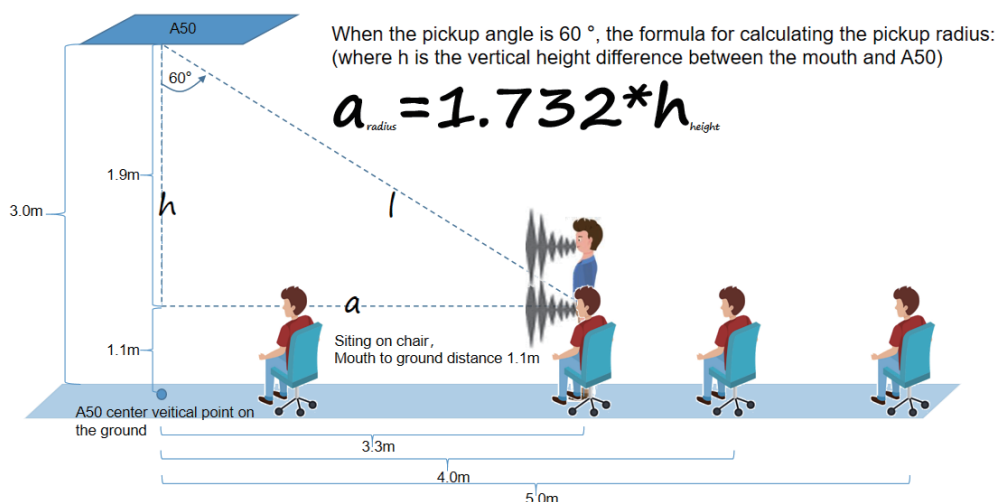

As shown in the above figure, if the lifting height of the A50 is 3.0 meters, the pickup radius is about 3.3~3.5 meters while in sitting status (around 1.1m height), and the range will be smaller in the stand up, namely at the edge of the 3.3~3.5 meters position, the pickup effect will be slightly reduced while people stand up. Similarly, sitting in 4.0 meters and 5.0 meters from the A50 center vertical point, the A50 can also pick up the speaker's voice, but the pickup effect will be slightly reduced compared to the position inside 3.3 meters.

5.4.5 A50 Indicators

- Yellow-green light: device power on
- Blue and white light flashes slowly: Device in upgrading
- Pure red light: Device Muted
- Blue-green light: Device in hybrid mode
- Remote Meeting mode: Blue and white light: Device in remote meeting mode
- Solid blue light: Device in local sound reinforcement mode

● 5.5 Deployment of ASP110

5.5.1 Power supply of ASP110

ASP110 is a wall mounted loudspeaker, passive 4Ω/15W. It is not recommended to use a third-party speaker. If really need use third-party speaker, it must meet the passive 4Ω/15W specification.

5.5.2 Cable length/cabling

Network cable length

ASP110 is equipped with a 25m audio cable as standard. If the length of the standard 25m audio cable is not enough for the actual customer's conference environment deployment, you can purchase the audio cable by yourself.

Laying and cabling

The audio cable shall be wired in the pipe slot in the ceiling and wall, and shall not be wired together with the strong current cable, which is easy to cause electromagnetic interference and generate current noise.

5.5.3 Wiring mode

ASP110 wiring mode is using audio terminal, red terminal is positive (+), black terminal is negative (-); The AMX100 side is the Phoenix terminal wiring mode. When facing to the Phoenix terminal, the left side is positive (+) and the right side is negative (-). The specific wiring diagram is as follows:

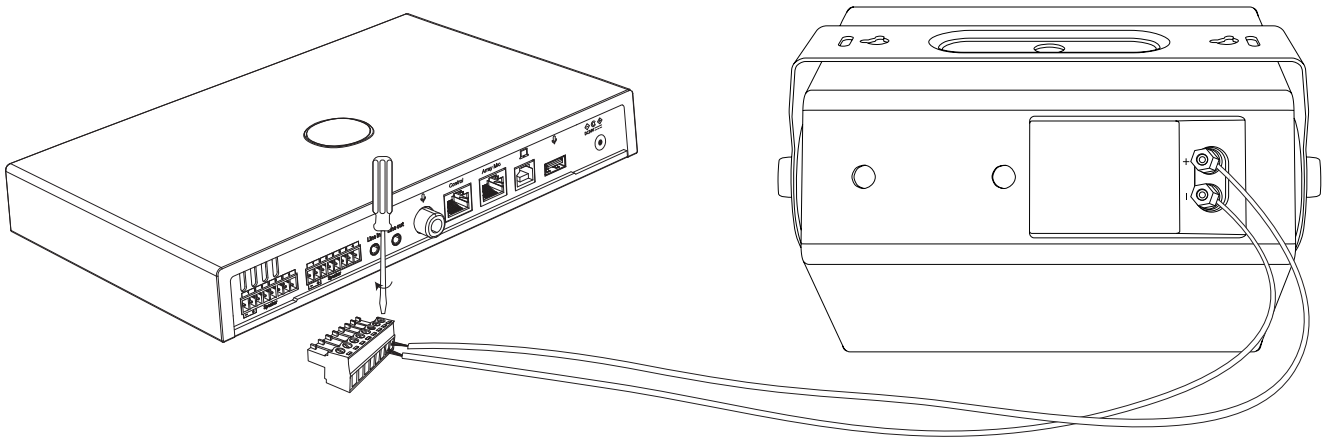

Before installation, please prepare suitable screwdriver, scissors or wire stripper in advance.

5.5.4 ASP110 Installation height/angle

Installation height

ASP110 wall mounted loudspeaker shall be installed as high as possible (if the installation height can be same with the A50 horizontal height, that will be better). To avoid the pickup beam range of A50, the loudspeaker shall be as far away from the A50 beam as possible.

Installation angle

ASP110 wall mounted speaker has its own wall mounted parts, which can be rotated left and right (vertical mounting) to adjust the angle or up and down (horizontal mounting) to adjust the angle.

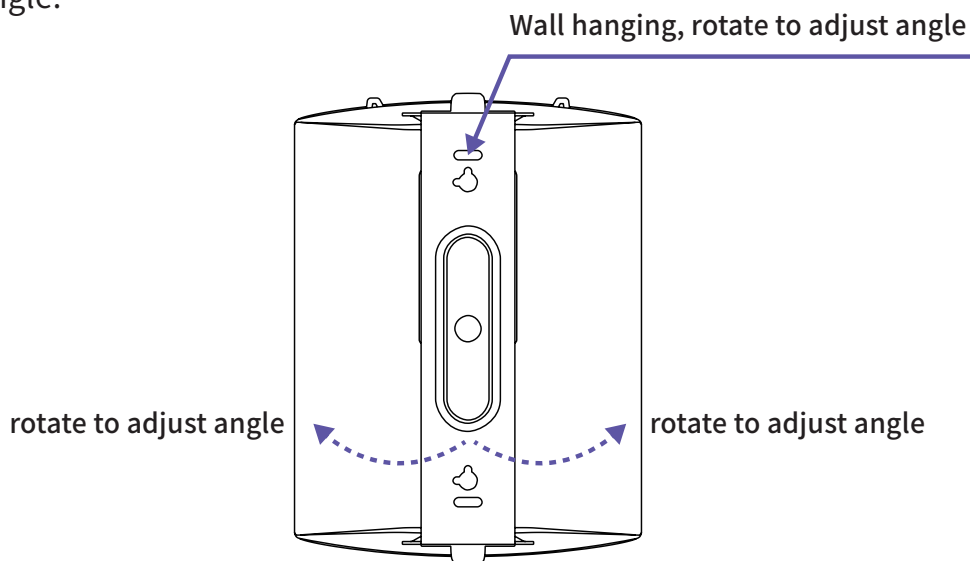

When the ASP110 is installed at the same height as the A50, in the vertical mounting mode, sometimes it is hoped that the audience will have a better voice experience, so speaker should be tilted downward for sound reinforcement. However, the angle cannot be adjusted downward in the vertical mounting mode, and other installation accessories need to be purchased.

The ASP110 speaker should not face to the A50. Especially in the local sound reinforcement scene, the A50 should not be deployed between the ASP110 speaker and the audience. In that case, the ASP110 speaker is faced to the A50 directly, which is not correct.

● 5.6 ACT10 Installation

5.6.1 Connection with AMX100

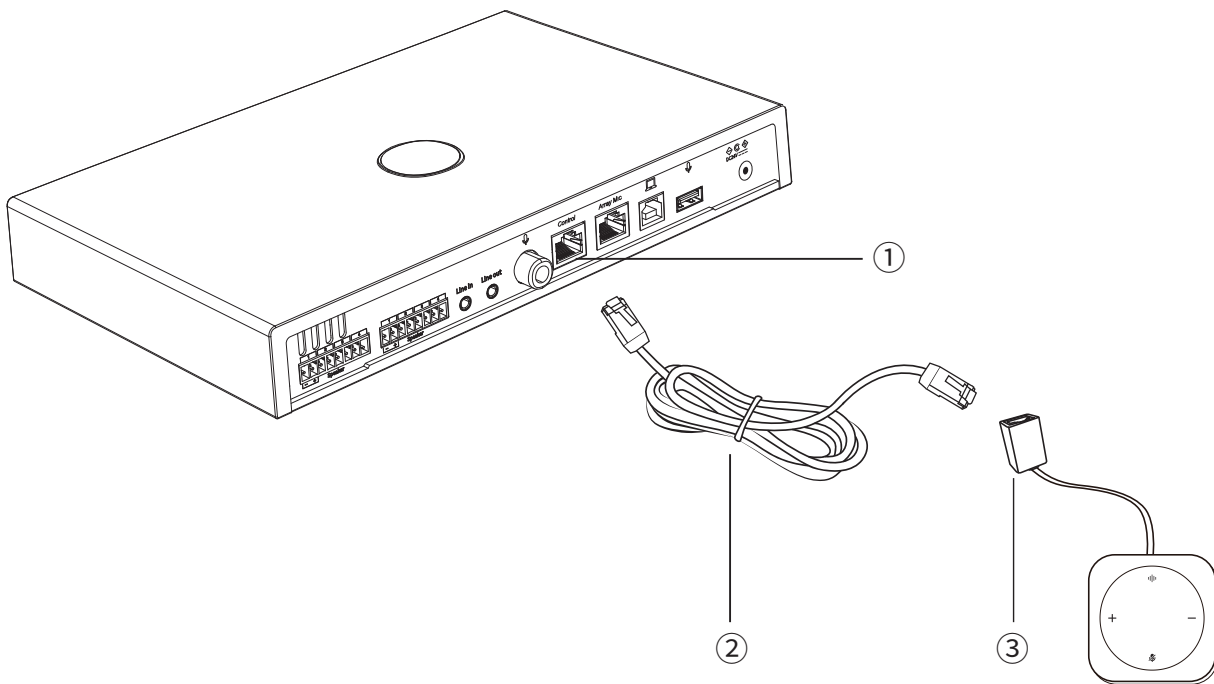

ASP110 wall mounted speaker has its own wall mounted parts, which can be rotated left and right (vertical mounting) to adjust the angle or up and down (horizontal mounting) to adjust the angle.

5.6.2 Indicators

- Yellow-green light: device power on
- Blue and white light flashes slowly: Device in upgrading
- Pure red light: Device Muted
- Blue-green light: Device in hybrid mode
- Remote Meeting mode: Blue and white light: Device in remote meeting mode
- Solid blue light: Device in local sound reinforcement mode

● 5.7 3rd A/V system integration

If the A50 must be integrated with the customer's existing A/V system in the project, it is recommended that the A50 package only be used as the pickup side, instead of deploying ASP110 speakers, use the existing speakers in the A/V system for sound reinforcement. The main considerations are as follows:

- For A50, remote conference mode shall be adopted as more as possible. If local sound reinforcement is necessary, we recommend to use handheld microphone to make sound reinforcement instead of A50;
- The sound reinforcement is on the A/V system side, so the audio output is on the A/V system side. The A50 package side saves a lot of trouble, such as the subsequent local sound reinforcement, the audio routing problems when the computer audio and video material is sharing (under the local conference or remote conference), the current noise

of speaker, and the consistency problem of the volume when there are multi-channel audio streams go to the loudspeaker for sound reinforcement, etc..

Precautions for A/V system integration are also mentioned in previous chapters, mainly including:

- Sound insulation and noise elimination device is used to eliminate electric current noise;
- Pay attention to the specifications of audio connecting cable connectors, especially male and female;
- Pay attention to the design and planning of audio routing to avoid echo;
- Pay attention to the realization of audio flow direction and switching in two scenarios when audio playback scenario when the audio and video materials on the speaker's laptop are shared and played: 1, In the local conference (without turn on the conference terminal); 2, In the remote conference (with the conference terminal holding the remote conference).
- The A50/AMX100 does not support central control, scene configuration switching, and there is no solution temporarily for complex changing conference room scenarios (such as switching 3 small conference rooms to one big conference room).

6. Operation on Software-Nearsync Configuration

• 6.1 Download and Installation of Nearsync

Download the Nearsync on the official website. <https://nearity.co/resources/dfu>

The image shows the Nearsync website and its software interface. The website header includes the Nearsync logo and navigation links: PRODUCTS, SOLUTIONS, SOFTWARE, PARTNERS, RESOURCE, and COMPANY. There are also links for 'Blog' and 'Contact Sales'. The main content area features the title 'NEARSYNC' and a description: 'We offer video conferencing devices management software, with the capability to support hybrid and remote workforces.' Below this are two buttons: 'GET STARTED NOW' and 'WATCH VIDEO'. A link 'Already have an account? Sign in' is also present. The software interface is shown in the foreground, displaying a 'V520D / Device Info' screen with fields for Room, Device Name, Device Type, Firmware Version, and Serial Number.

Install NearSync

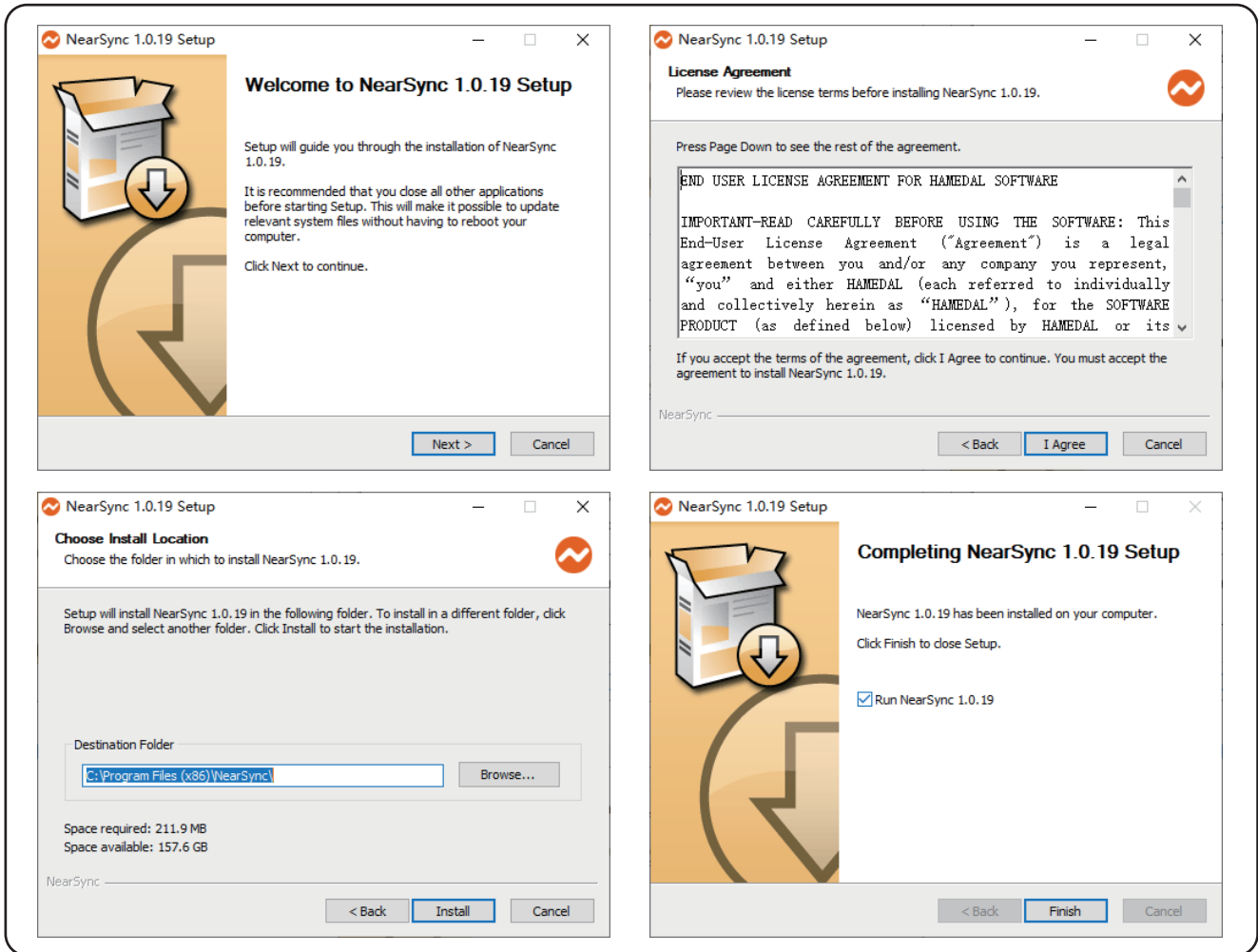

• 6.2 Software Configuration

6.2.1 NearSync Main interface instruction

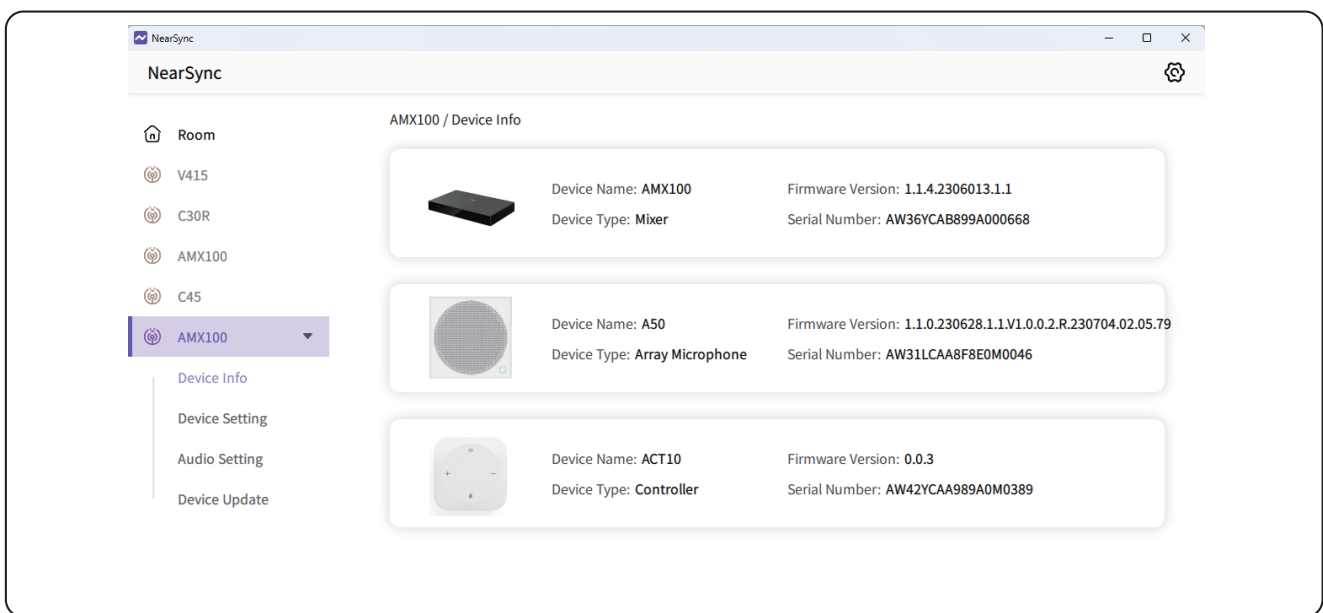

It will show the device info in this page. If there are multiple A50s daisy-chained, you can distinguish by the SN.

6.2.2 Device Setting



6.2.2.1 A50 Setting

A50 Selection

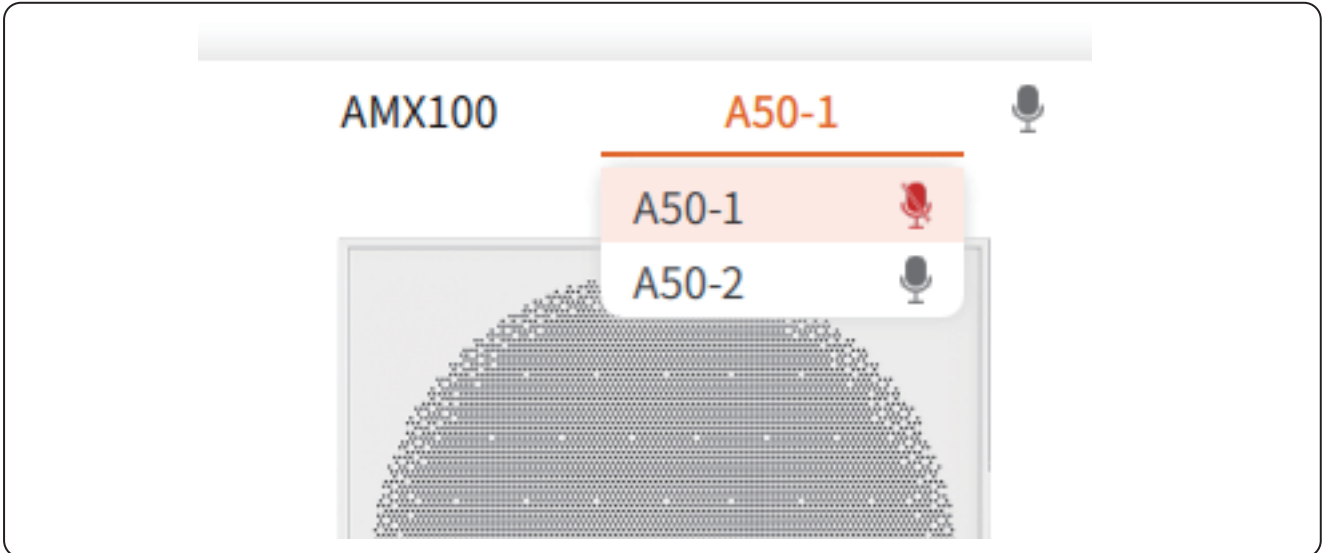
When there are multiple A50s, select A50 through the drop-down box and make corresponding settings.



Mute Settings

Check the mic icon,  means muted.  means muted.

Parameter Settings

Beam Selection

The A50 includes 12 beams. Currently, the NearSync tool only supports enable or disable these beams. The following figure shows the direction of the select-able beam relative to the A50 panel (in the picture, the A50 indicator is aligned with the lifting A50 indicator), and the corresponding beam can be checked and enabled in the NearSync tool as required (checked by default, namely enabled). For some application scenarios, for example, in the classroom the A50 only picks up the teacher's voice but not the student's voice, the beam facing the student side can be disabled (unchecked); in the local sound reinforcement scene, the beam pointing to the louder speaker can be disabled (unchecked).

In addition, if there is no special requirement, it is recommended to turn off the beam directly below (No.12 beam) to improve the signal-to-noise ratio and sound quality.

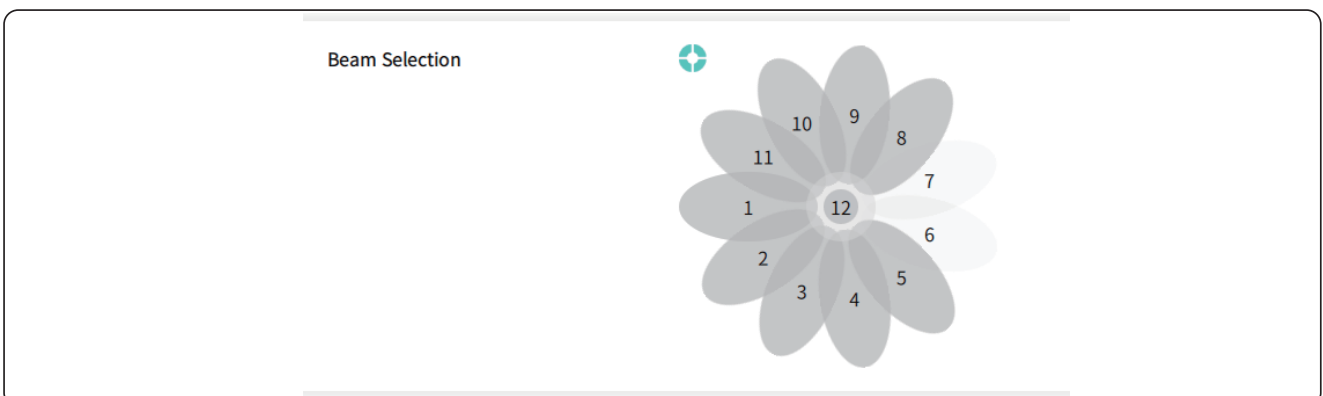

The beam selection can determine the corresponding direction and beam according to the icon position of the light. A total of 12 beams can be selected. If selected(as showed in the picture 6 and 7 selected, color turned to white), it means the beam is disabled, otherwise it means it is working normally(in gray color).

Audio Parameter Settings

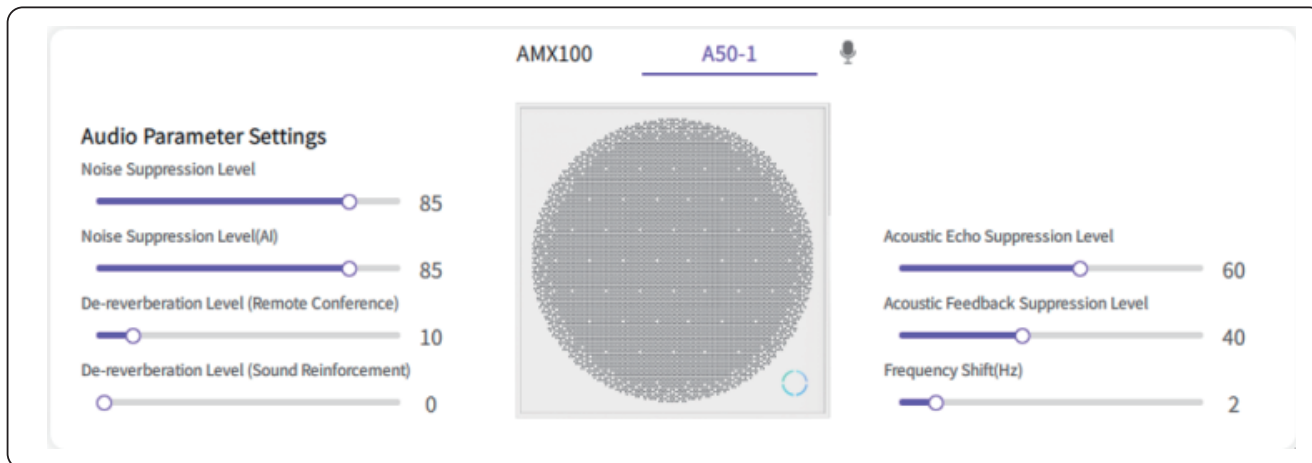

Noise Suppression level: this is to suppress the normal background constant noise. the value is 0-100, the larger the value, the higher the noise suppression level.

Noise Suppression level(AI): this is to suppress the normal background non-constant noise. the value is 0-100, the larger the value, the higher the noise suppression level.

De-reverberation level(remote conference): used in remote conferencing mode, the value is 0-100, the larger the value, the higher the de-reverberation level.

De-reverberation level(sound reinforcement): used in local sound reinforcement mode, the value is 0-100, the larger the value, the higher the de-reverberation level.

Echo Cancellation level: the value is 0-100, the larger the value, the higher the noise suppression level.

Feedback suppression level: the value range is 0 ~ 100, the larger the value, the higher the feedback suppression level, but it may cause the local amplification distortion.

Frequency Shift: used to adjust the feedback, the value range is 0-10, the larger the value, while other parameters remain unchanged, the less likely it is to appear feedback, and the volume of sound amplification will also be improved, but the sound distortion will become larger.

Equalizer

The equalizer is used to adjust the voice effect (suppression value) at different frequency.

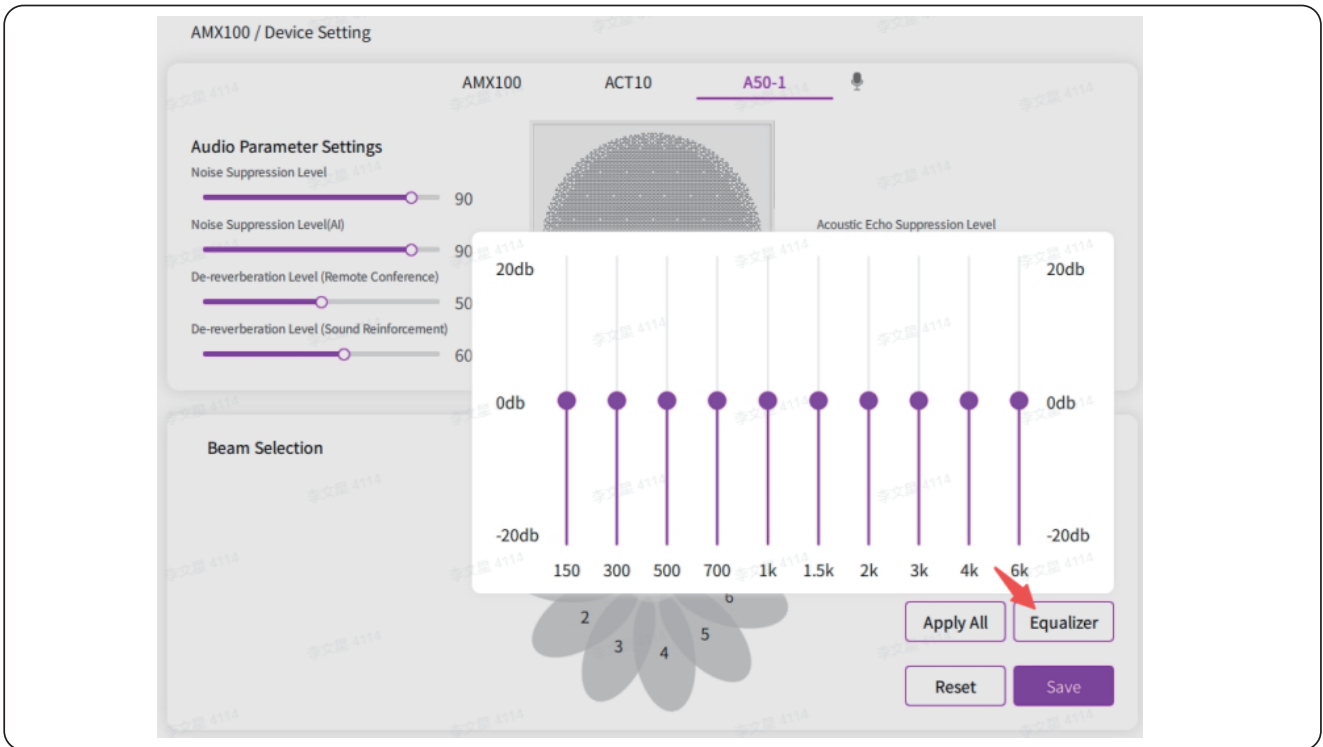

6.2.2.2 ACT10 Setting

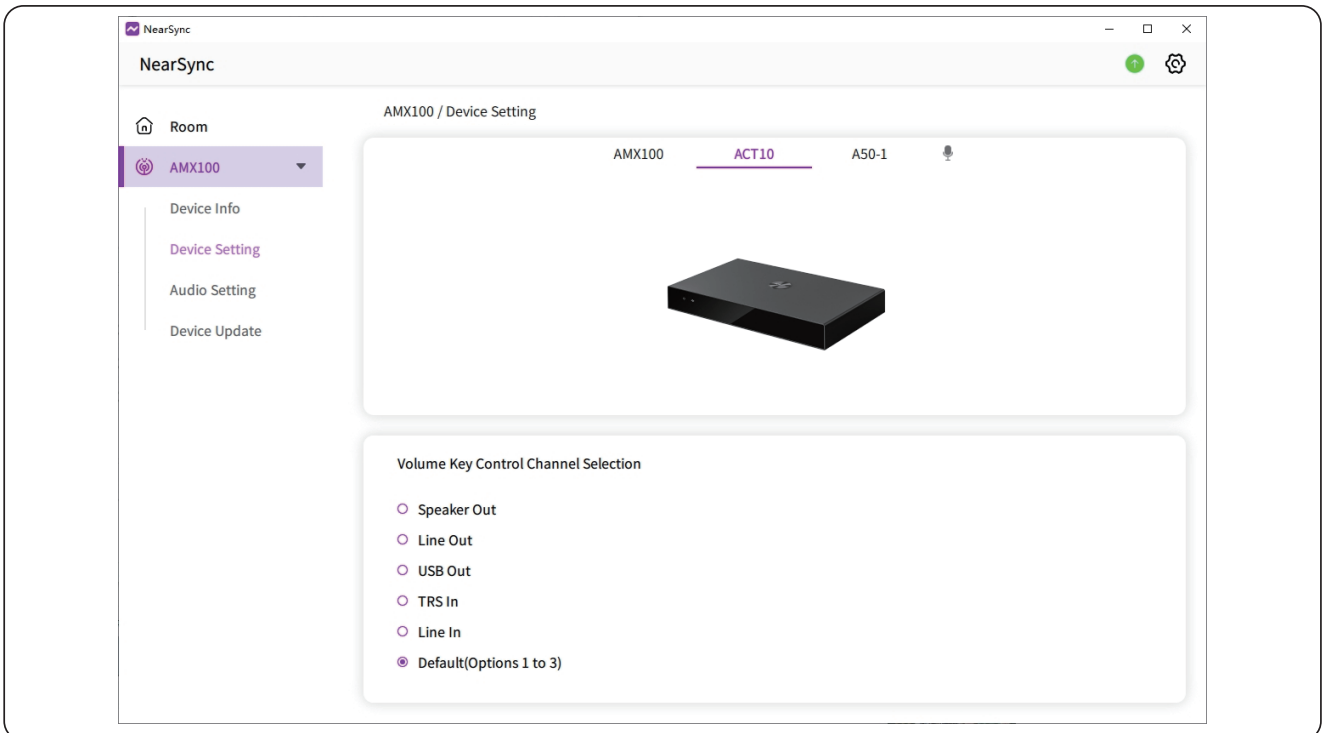

Volume keys control channel selection

By default, the Volume +/- button is used to control the output volume of the speaker/line out/USB out output channels.

ACT10 can be used to control the corresponding device by selecting the control channel. For example, when only the speaker output is selected, ACT10 can only adjust the volume of the broadcast output. Several different output channels can also be selected.

6.2.2.3 AMX100 Settings Interface

Click Audio setting to set the AMX100 audio routing mode

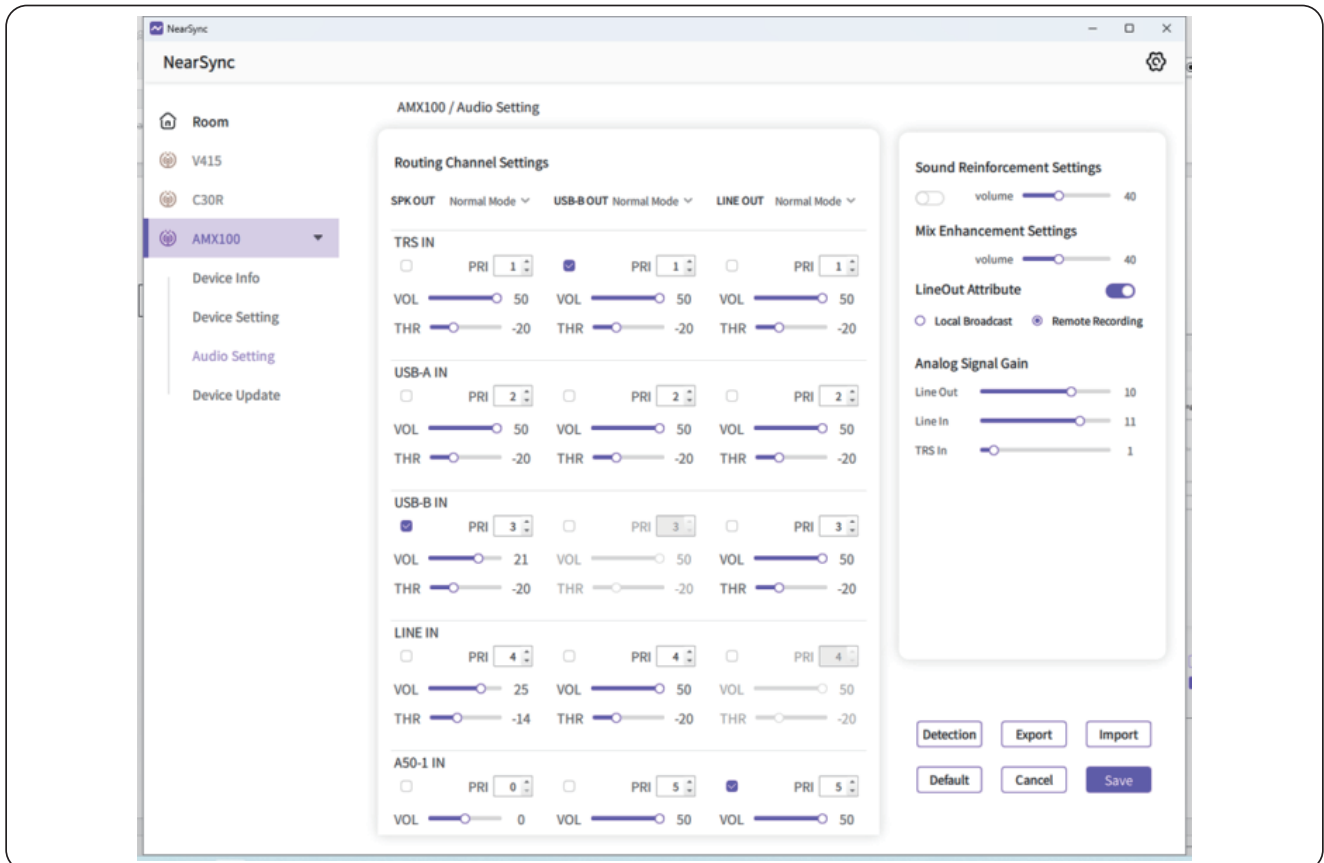

The parameters set in this interface are stored permanently and will not be changed after power off.

Routing Channel Settings

Routing Mode

Each output can select the routing mode individually. The current Speaker Output and USB-B Output both support normal mode and priority mode. Line Out Output only supports normal mode for the time being.

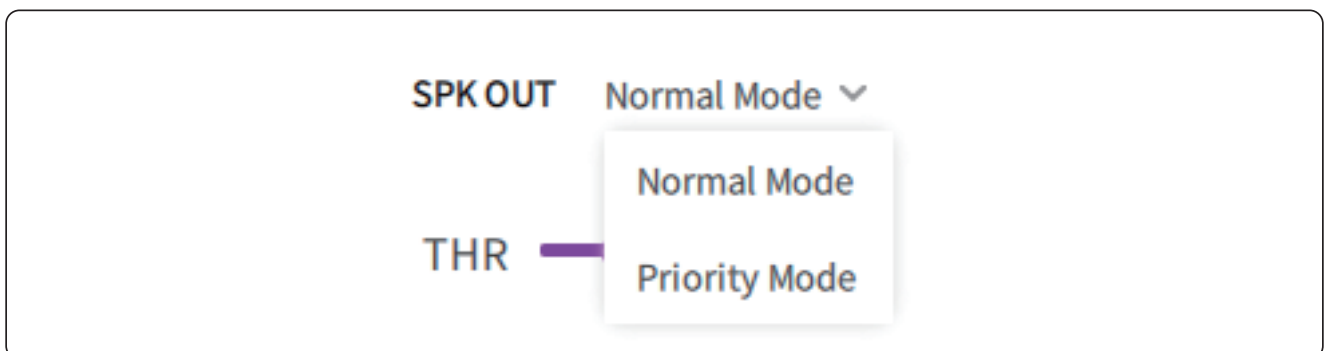

Normal Mode

Mix the selected multi-channel audio inputs indiscriminately and pass it to the output interface.

Priority Mode

As shown in the figure above, relevant parameters such as priority and threshold are

calculated corresponding to each input. The priority range is 0-16, and priority 0 is the highest priority. It is not recommended to use the same priority for multiple inputs. The selection logic is to perform polling according to the priority 0-16. When the input energy corresponding to a certain priority is greater than the threshold, the audio input of this channel is passed to the output, and when all channels do not reach the threshold, no output is performed.

Input Parameters

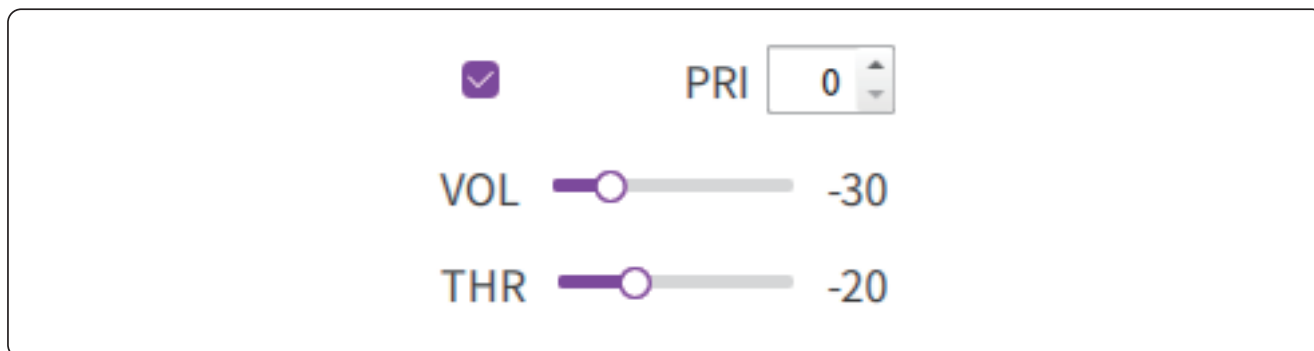

Volume: The adjustment range is 0-50, of which 50 is the default value, which means the volume will not be adjusted. Please note the change is digital adjustment, and it is not recommended to adjust too much. In addition, the volume adjustment is independent of each output. For example, adjusting the TRS input volume of Speaker Output will not affect the TRS input volume of USB-B Output.

Check box: Check the box means to pass the audio input to the corresponding output

Priority: Only take effect in priority mode, the value is 0-16, 0 means the highest priority, 16 means the lowest priority.

Threshold: Only valid in priority mode, the value is -20 by default, value range -50~50, the unit is dB.

Sound Reinforcement Settings

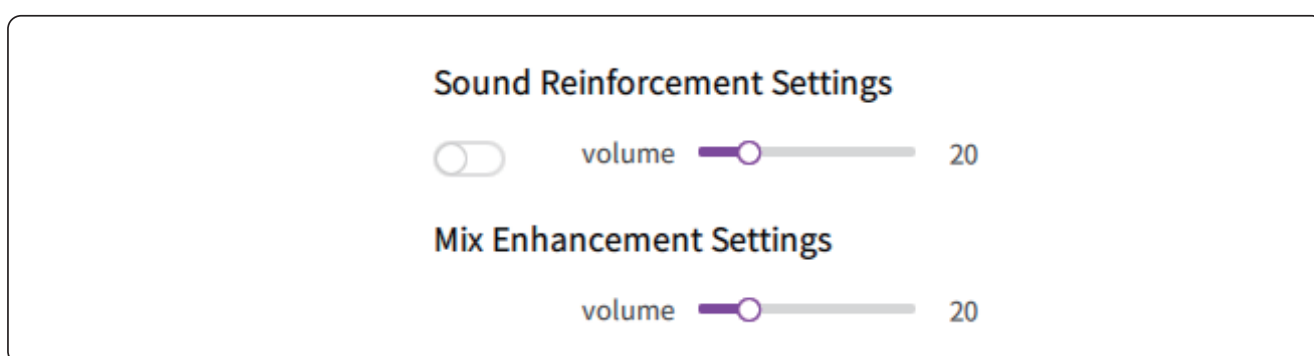

Check box: Check the box means enable sound reinforcement.

Sound reinforcement modes are divided into local sound reinforcement settings and mixed sound reinforcement settings. Respectively control the volume of sound reinforcement in local sound reinforcement mode and mixed mode.

Volume: the value is 0-100

Line Out Attribute

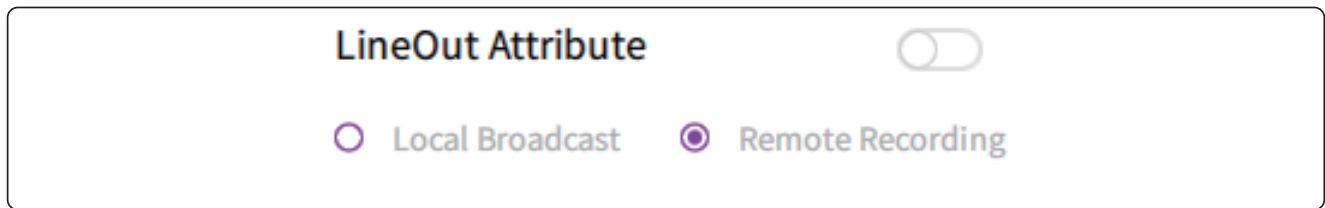

Local broadcast: suitable for connecting to a local amplifier for audio playback, the sound picked up by A50 will be processed accordingly

Remote recording: suitable for connecting to the traditional audio meeting server, the sound is transmitted to the far end

Analog Signal Gain

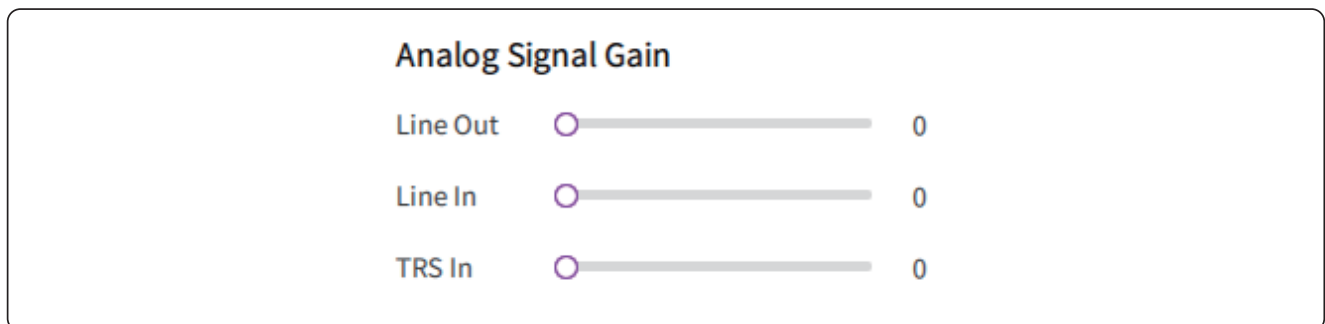

There are three analog audio interfaces on the DSP, and the analog audio gain can be set as follows:

Line Out: The value is 0-14, where 10 represents 0dB, and the downward and upward changes are 5dB respectively.

Line In: The value is 0-14, where 0 represents 0dB, and the upward change is 2dB

TRS Input: The value is 0-14, where 0 represents 0dB, and the upward change is 2dB

Detection

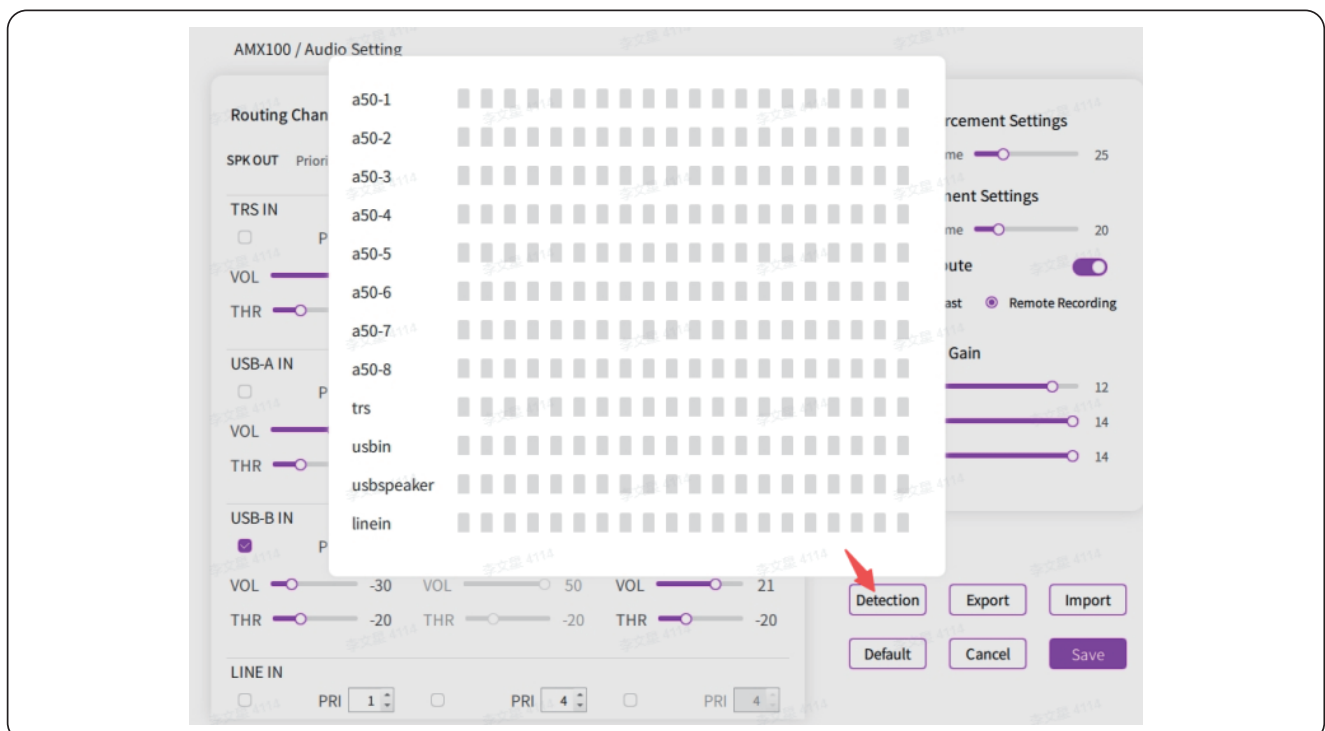

The Detection feature is used to detect the volume output of connected devices and troubleshoot hardware-related issues with external audio devices in abnormal situations.

6.2.2.4 Device Update

Online update



It will show the latest firmware version under each mode. Click “update” to start updating.

Local update

Before local update, contact Nearity team to confirm the firmware version.

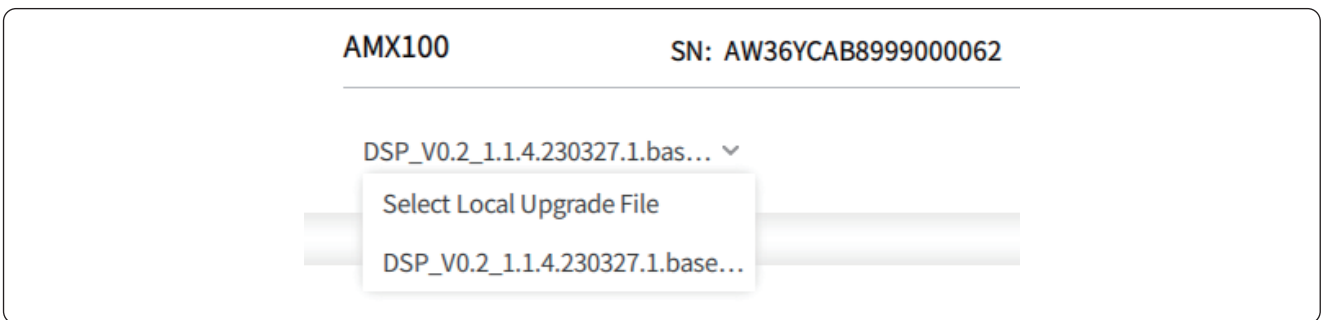

1, select local upgrade file

2, click “update” to choose the bin file on your PC/laptop, and then it will start updating.

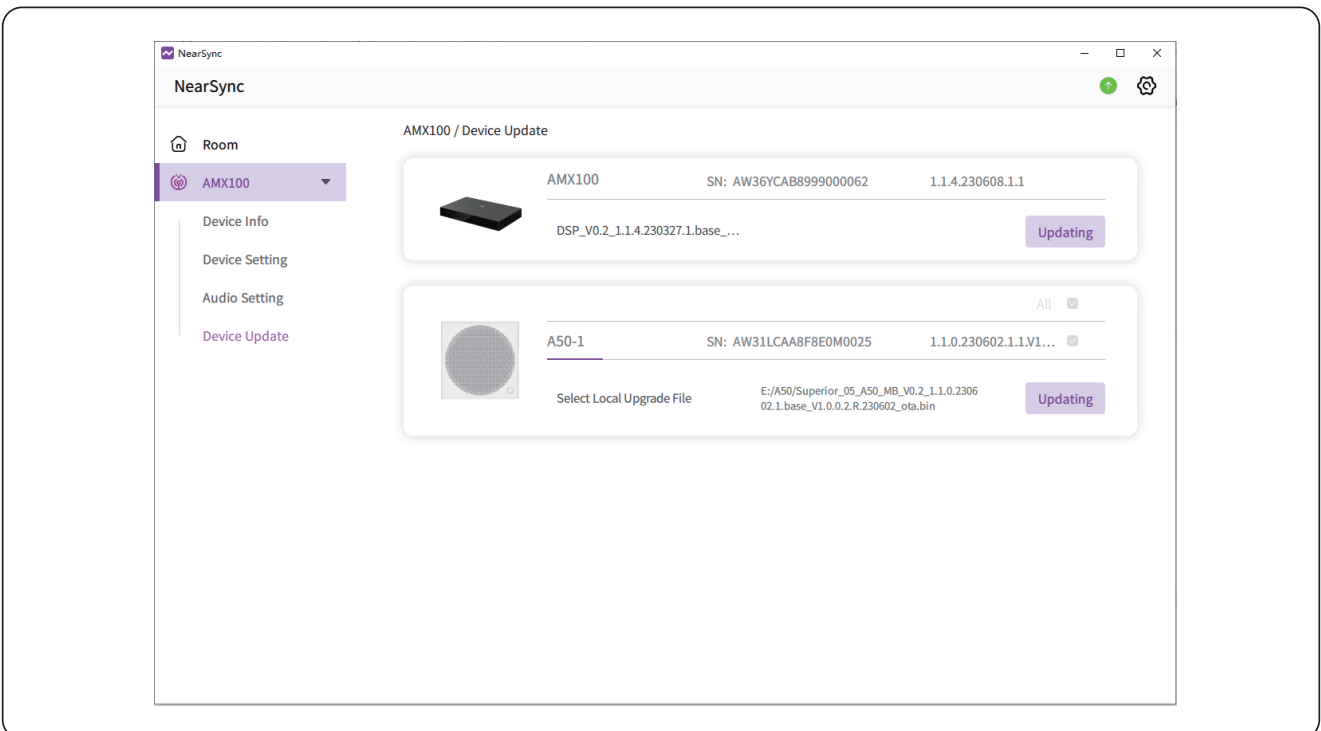

7. FAQ

Q: What loud-speaker can we use to pair with ceiling Mic A50?

A: Nearity loudspeaker ASP110 and ASP100 are available. You can also use 3rd party loudspeaker to connect with AMX100 DSP for the audio routing.

Q: Does A50 Supported connecting with 3rd party DSP?

A: Doesn't Supported. Right now the A50 can only Supported connect with Nearity DSP AMX100.

Q: Why I cannot find Nearity A50 in the VC software microphone list?

A: The A50 is connect to AMX100 and then do the audio routing. So we should choose AMX100 while we use the A50 system.

Q: What's the insallation height of A50?

A: It depends on the room side. Generally we recommand to install the A50 range 2.8~4.5 meters to the ground.

8. Caution

Although this product was designed to be used safely, failing to use it correctly may result in an accident. To ensure safety, observe all warnings and cautions while using the product.

The product is intended for commercial use, not for general use.

Disconnect the product from a device if the product begins to malfunction, producing smoke, odor, heat, unwanted noise or showing other signs of damage. In such a case, contact your local Nearity supplier.

- Do not disassemble, modify or attempt to repair the product to avoid electric shock, malfunction or fire.
- Do not subject the product to strong impact to avoid electric shock, malfunction or fire.
- Do not handle the product with wet hands to avoid electric shock or injury.
- Do not allow the product to get wet to avoid electric shock or malfunction.
- Do not put foreign matter such as combustible materials, metal, or liquid in the product.
- Do not cover the product with a cloth to avoid fire or injury by overheating.
- Keep the product out of the reach of small children. The product is not intended for use around children.
- Do not place the product near fire to avoid an accident or the product catching fire.
- Do not put the product in a location where it is exposed to direct sunlight, near heating devices, or in places with high temperatures, high humidity, or high concentrations of dust to avoid electric shock, fire, malfunction, etc.
- Keep away from a fire to avoid deformation or malfunction.
- Do not use chemicals such as benzine, thinner, electrical contact cleaner, etc. to avoid deformation or malfunction.